

311F L RR

Hydraulic Excavator

2017



Engine

Engine Model	Cat® C3.4B	
Engine Power – ISO 14396	55 kW	74 hp
Net Power – SAE J1349/ISO 9249	52 kW	70 hp

Drive

Maximum Travel Speed	5.4 km/h	3.4 mph
Maximum Drawbar Pull	114 kN	25,700 lbf

Weight

Minimum Operating Weight	12 400 kg	27,300 lb
Maximum Operating Weight	13 900 kg	30,600 lb

Introduction

Get your work done with a lot less fuel.

If you want a machine with the power to match your jobs but owning and operating costs to fit your business, then the Cat 311FL RR excavator is your answer. Its reduced radius will get you into some pretty tight spots, and its reasonable price and miserly fuel burn will help you operate on a tight budget.

The machine's C3.4B engine meets U.S. EPA Tier 4 Final, EU Stage IIIB, and Japan 2014 (Tier 4 Final) emission standards and comes equipped with fuel savers like engine idle shutdown and eco mode to help you manage consumption. It also comes with an extremely quiet and comfortable cab to help you stay productive all day long.

Whether you are truck loading or stockpiling, trenching or digging, leveling or grading, you will be pleased with the reliable, fuel-saving performance you will get from the all-new Cat 311FL RR.

Contents

Reduced Radius	4
Engine	5
Hydraulics	6
Structures and Undercarriage	7
Operator Station.....	8
Front Linkage	10
Integrated Technologies.....	11
Attachments.....	12
Safety	14
Serviceability	15
Complete Customer Care.....	16
Sustainability	17
Specifications.....	18
Standard Equipment.....	33
Optional Equipment.....	34





The Cat 311F L RR delivers fuel savings and performance – two attributes you need to be successful in your business.

Reduced Radius

The right choice for your space-restricted work



Tight Job, Right Machine

With more and more jobs requiring work in tight spaces, a reduced radius machine is the right choice for you. The 311F L RR's tail swing radius is just 1750 mm (5'9"). When rotated 90 degrees and working over the side, only 505 mm (1'8") hangs over the side – ideal when you are working up against a wall, on a narrow road, or other space-restricted area.

Stable Platform

The 311F L RR offers a stable platform for all applications. One of the main contributors is the 2.45 mt (5,400 lb) counterweight. This allows the shorter 311F L RR to perform like a longer tail swing machine.



Comfortable Full-Size Cab

While the length of the upper structure is reduced to accommodate the work at hand, the cab of the 311F L RR is not. It's the same size as our standard machines with all the amenities you've come to expect.

Engine

Powerful and fuel efficient to meet your expectations

A Unique Emissions Solution

The Cat C3.4B engine meets Tier 4 Final, Stage IIIB, and Japan 2014 (Tier 4 Final) emission standards. It provides plenty of power for the utility work you do and won't consume a lot of fuel to do it – all to help keep your owning and operating costs to an absolute minimum.

Fuel-Saving Features

One built-in fuel-saving feature is engine idle shutdown, which automatically turns the engine off when it's been idling for more than a specified amount of time. You can also choose eco mode to more actively manage fuel consumption for the job at hand. Both will help you save fuel, reduce emissions, and extend your service intervals.

Biodiesel Ready

The C3.4B engine can run on up to B20 biodiesel fuel that meets ASTM 6751 standards – all to give you more potential fuel-saving flexibility.



Proven Technology

Every Tier 4 Final, Stage IIIB, and Japan 2014 (Tier 4 Final) engine is equipped with a combination of proven electronic, fuel, air, and aftertreatment components. Applying proven technologies lets us meet your high expectations for productivity, fuel efficiency, reliability, and service life. The right technologies fine tuned for the right applications results in:

- **High performance** across a variety of applications
- **Maximized uptime and reduced cost** with world-class support from the Cat dealer network
- **Minimized impact** of emission systems – designed to be transparent to the operator without requiring interaction
- **Durable** designs with long life to overhaul
- **Better fuel economy** with minimized maintenance costs while providing the same great power and response

More Powerful, Reliable Engine Electronics

The electronics used in Cat Tier 4 Final, Stage IIIB, and Japan 2014 (Tier 4 Final) engines are more powerful and robust than ever. Enhanced features increase quality and reliability, which improves your owning and operating experience.

Next Generation Fuel Systems

As a key component of Cat Tier 4 Final, Stage IIIB, and Japan 2014 (Tier 4 Final) Technology, injection timing provides more control of combustion for the cleanest, most efficient fuel burn. To maximize your value, Caterpillar engineers specified fuel systems based on the power and performance demands for each engine.

Innovative Air Management

Cat Tier 4 Final, Stage IIIB, and Japan 2014 (Tier 4 Final) engines feature innovative air management systems that optimize airflow and enhance power, efficiency, and reliability. We apply a range of simple, reliable turbo charging solutions based on engine size and application. This allows us to match turbo performance to rated output for high productivity, excellent fuel efficiency, long life, and low operating costs for you.

Hydraulics

Made to move your material with speed and precision

Efficient Design

Major hydraulic components like pumps and valves are located close together to make it possible to use shorter tubes and lines. This design leads to less friction loss in the lines, reduced pressure drops, and more power to the ground for the work you need to get done.

Control Like No Other

Controllability is one of the main attributes of Cat excavators, and one of the key contributors to this is the main control valve. The valve opens slowly when your range of joystick lever movement is small and opens rapidly when movement is high. It puts flow where you need it when you need it, which leads to smoother operation, greater efficiency, and lower fuel consumption.

Auxiliary Hydraulics for Added Versatility

Auxiliary hydraulics give you greater tool versatility so you can take on more work with just one machine, and there are several options from which you can choose. A quick coupler circuit, for example, will allow you to switch from one tool to another in a matter of minutes – all from the comfort and convenience of the cab.

Electric Boom and Stick Regeneration for Added Efficiency

The 311F regenerates the flow of oil from the head end of the boom cylinder to the rod end of the boom cylinder during the work cycle to save energy and improve fuel efficiency. It's optimized for any dial speed setting you select, which results in less pressure loss for higher controllability, more productivity, and lower operating costs. The machine also regenerates the flow of oil from the rod end of the stick cylinder to the head end of the stick cylinder during operation to increase speed.





Structures and Undercarriage

Made to work in your tough utility applications

Robust Frames

The 311F is a well-built machine that's designed to give you a long service life. The upper frame includes special mountings made specifically to support the heavy-duty cab; the lower frame is reinforced to enhance component durability so you can count on the machine doing the work you need done.

Durable Undercarriage

Long undercarriage is standard and works extremely well in various work applications and conditions. Track shoes, links, rollers, idlers, and final drives are all built with high-tensile-strength steel for long-term durability.

Great Weight

The available 2.45 mt (5,400 lb) counterweight has a surface that matches the 311F L RR's overall sleek appearance. It provides plenty of balance for your heavy lifting and is bolted directly to the main frame to ensure rigidity. It also has an integrated housing to protect the optional rearview camera.



Operator Station

Comfort and convenience to keep you productive



A Safe and Quiet Cab

The Roll-Over Protective Structure (ROPS) certified cab is not only a safety feature, but it is also a sound suppressor due to its special sealing and insulation. With the door and windows closed, you will experience a machine that's as quiet as the truck you drive to work.

A Cool (and Warm) Environment

The automatic climate control system features multiple air outlets with filtered ventilation. Air flows on the floor, behind the seat, and in front of you to make your work in either hot or cold weather much more pleasant and productive.

Comfortable Seat Options

The suspension seat provides a variety of adjustments to accommodate a wide range of operators. All seats include a reclining back, upper and lower slide adjustments, and height and tilt angle adjustments to meet your needs for maximum comfort and productivity.



Controls Just for You

The right and left joystick consoles can be adjusted to improve your comfort and productivity during the course of a day. Also, the right joystick features a button that will reduce engine speed when you are not working to help save fuel. Touch it once and speed reduces; touch it again and speed increases for normal operation.



An Easy-to-Use Monitor

The LED monitor is easy to see and navigate. Programmable in up to 42 languages to meet today's diverse workforce, the monitor clearly displays critical information you need to operate efficiently.



Ample Storage and Auxiliary Power

Storage spaces are located in the front, rear, and side consoles of the cab. A drink holder accommodates a large mug with handle, and a shelf behind the seat stores large lunch or toolboxes. Power supply sockets are conveniently located near the key storage areas for charging your electronic devices like an MP3 player, a cell phone, or a tablet.





Front Linkage

Take on your far-reaching or up-close tasks

Boom and Stick

The 311F L RR is offered with a 4.3 m (14'1") reach boom and two reach stick options. This configuration offers you excellent all-around versatility and a large working envelope.

- The 2.8 m (9'2") reach stick is the most versatile option and a very good fit for truck loading and trenching applications where you need additional working range.
- The 2.25 m (7'5") reach stick is ideally suited to applications requiring larger bucket sizes. It maximizes digging forces and enables you to get your jobs completed faster.

Built to Last

All Cat booms and sticks are built with internal baffle plates for added durability, and all undergo ultrasound inspection to ensure weld quality and reliability. Large box-section structures with thick multi-plate fabrications, castings, and forgings are used in high-stress areas such as the boom nose, boom foot, boom cylinder, and stick foot to improve durability. Also, the front linkage pins' inner bearing surfaces are welded with a self-lubricated bearing used to extend service intervals and increase uptime.

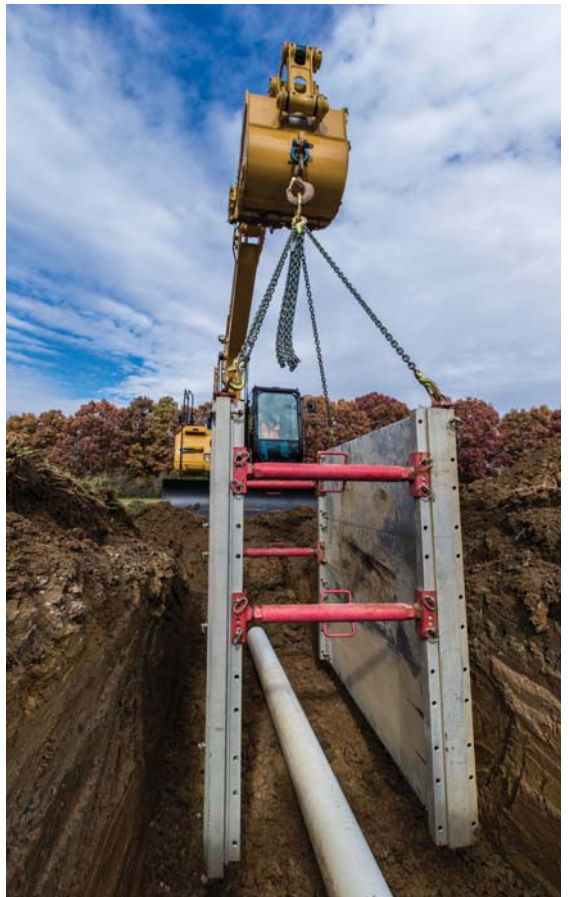

Integrated Technologies

Monitor, manage, and enhance your job site operations



Cat Connect makes smart use of technology and services to improve your job site efficiency. Using the data from technology-equipped machines, you'll get more information and insight into your equipment and operations than ever before.

Cat Connect technologies offer improvements in these key areas:



EQUIPMENT
MANAGEMENT

Equipment Management – increase uptime and reduce operating costs.



PRODUCTIVITY

Productivity – monitor production and manage job site efficiency.



SAFETY

Safety – enhance job site awareness to keep your people and equipment safe.



Featured Cat Connect technologies include:

Link

Link technologies provide wireless capability to machines to enable two-way transfer of information collected by on-board sensors, control modules, and other Cat Connect technologies using off-board apps such as our VisionLink® software.

Manage Your Machine Remotely

Cat Product Link™ is an optional system that is deeply integrated into the machine monitoring system to take the guesswork out of managing your equipment. The system tracks location, hours, fuel usage, productivity, idle time, and diagnostic codes through the online VisionLink interface to help you maximize efficiency, improve productivity, and lower operating costs. Manage the data yourself or get expert advice from your Cat dealer to keep your equipment operating at peak performance.

Attachments

Tools to make you productive and profitable



Get the Most Out of One Machine

The 311F L RR is a highly versatile machine that packs a lot of performance into a small package. You can easily expand that performance by utilizing any of the variety of attachments offered by Cat Work Tools.

Change Jobs Quickly

A quick coupler brings the ability to quickly change attachments and switch from job to job. The Cat Pin Grabber coupler is the secure way to decrease downtime and increase job site flexibility and overall productivity.

Dig, Finish and Compact

A wide range of buckets dig everything from top soil to highly abrasive material. For finishing and grading work, compact and shallow ditch cleaning buckets fit the need. A Cat compactor prepares the area for the next phase of construction.

Break, Demolish and Scrap

A hydraulic hammer equips the 311F for breaking sidewalks, driveways, and pavement. A shear allows you to cut metal down to size for recycling or transport.

Move and Handle All Sorts of Material

Choose a thumb to work with your bucket and gain the instant ability to move and handle brush, rocks, and debris at your construction site. When your job requires constant material handling, a grapple may be your solution. Choose from three different grapple styles for loading, sorting and picking – whether it be trash, demolition debris or recyclables.

Set Up Your Machine for Maximum Profitability

Your Cat dealer can install hydraulic kits to properly operate all Cat Work Tool attachments – maximizing the machine's uptime and your profits.

GRAB, SORT, LOAD



Pro Series Hydraulic Thumbs



Stiff Link Thumbs



Contractors' Grapples



Trash Grapples

SWAP TOOLS



Center-Lock™ Pin Grabber Coupler

DIG & PACK



Ditch Cleaning and Tilt Buckets



General Duty Buckets



Vibratory Plate Compactors

Safety

Features to help protect you day in and day out

A Safe and Quiet Cab

You will benefit from the enhanced protection of a ROPS-certified cab. Not only is it safe, but its special roof lining and sealing make the sound inside comparable to any of today's top pickup trucks. In fact, it's so quiet you won't believe the machine is running.

Secure Contact Points

Your slipping hazards are reduced with anti-skid plates on the surface of the upper structure and the top of the storage box area. The plates are effective in all types of weather conditions, and they can be removed for cleaning. Large steps as well as hand rails allow you to confidently and safely work with the machine. Steps on the track frame will get you into the cab as well as a leg up to the compartments. Extended hand rails allow you to safely climb to the upper deck. An additional hand rail above the air cleaner compartment gives you a holding point while standing on the track.

Great Visibility

Ample glass gives you excellent visibility out front and to the side, and the available rearview camera gives you a clear field of view behind the machine through the cab monitor. The split-configuration windshield features an upper window with handles that make it easy to slide and store above you and a lower window that can be removed and stored on the inside wall of the cab. The large skylight provides you with enhanced visibility and also serves as an emergency exit. Halogen lights provide plenty of illumination and can be programmed to stay on for up to 90 seconds after the engine has been turned off to help you safely exit the machine.

A Worthwhile Guard Option

Easy-to-install front and door window vandal guards are available to help protect your machine from unwanted attention. They conveniently store in the lockable box that serves as an anti-skid step up to the engine platform.



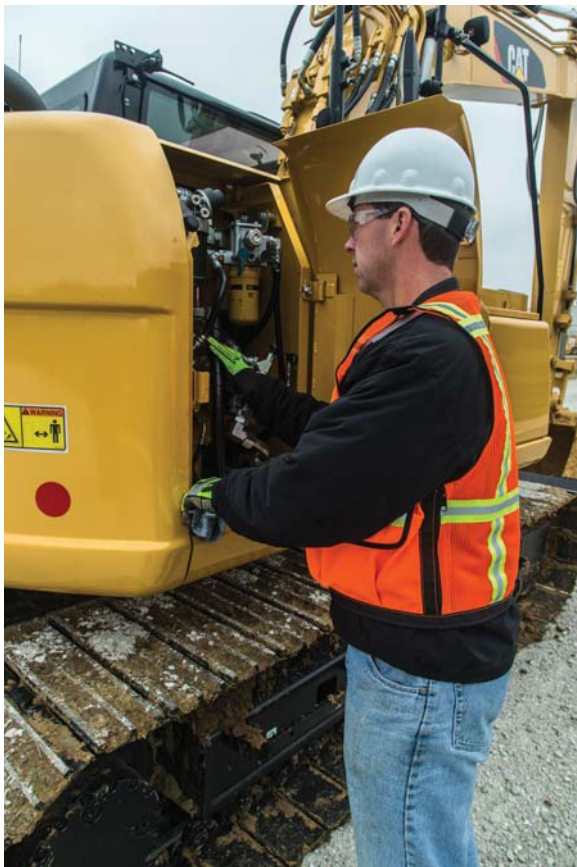

Serviceability

Designed to make your maintenance quick and easy

Ground-Level Access Built In

You can easily reach fluid taps and grease points from the safety and convenience of ground level. Not only do compartments feature wide service doors designed to help prevent debris entry, but they also securely latch in place to help make your service work simpler.

A Cool Design

The unique cooling package includes a screen between the radiator and AC condenser to prevent plugging. In addition, wider clearance is provided between the radiator and AC condenser to help make blowing off debris easy for you, which can help improve your machine's reliability and performance in high ambient conditions.

A Fresh Idea

When you select ventilation inside the cab, outside air enters through the fresh air filter. The filter is conveniently located on the side of the cab to make it easy to reach and replace, and it is protected by a lockable door that can be opened with the engine key.

Other Service Benefits

The fuel tank's drain cock makes it easy and simple for you to remove water and sediment during routine maintenance. Plus an integrated fuel level indicator pops up to help you reduce the possibility of fuel tank overfilling.

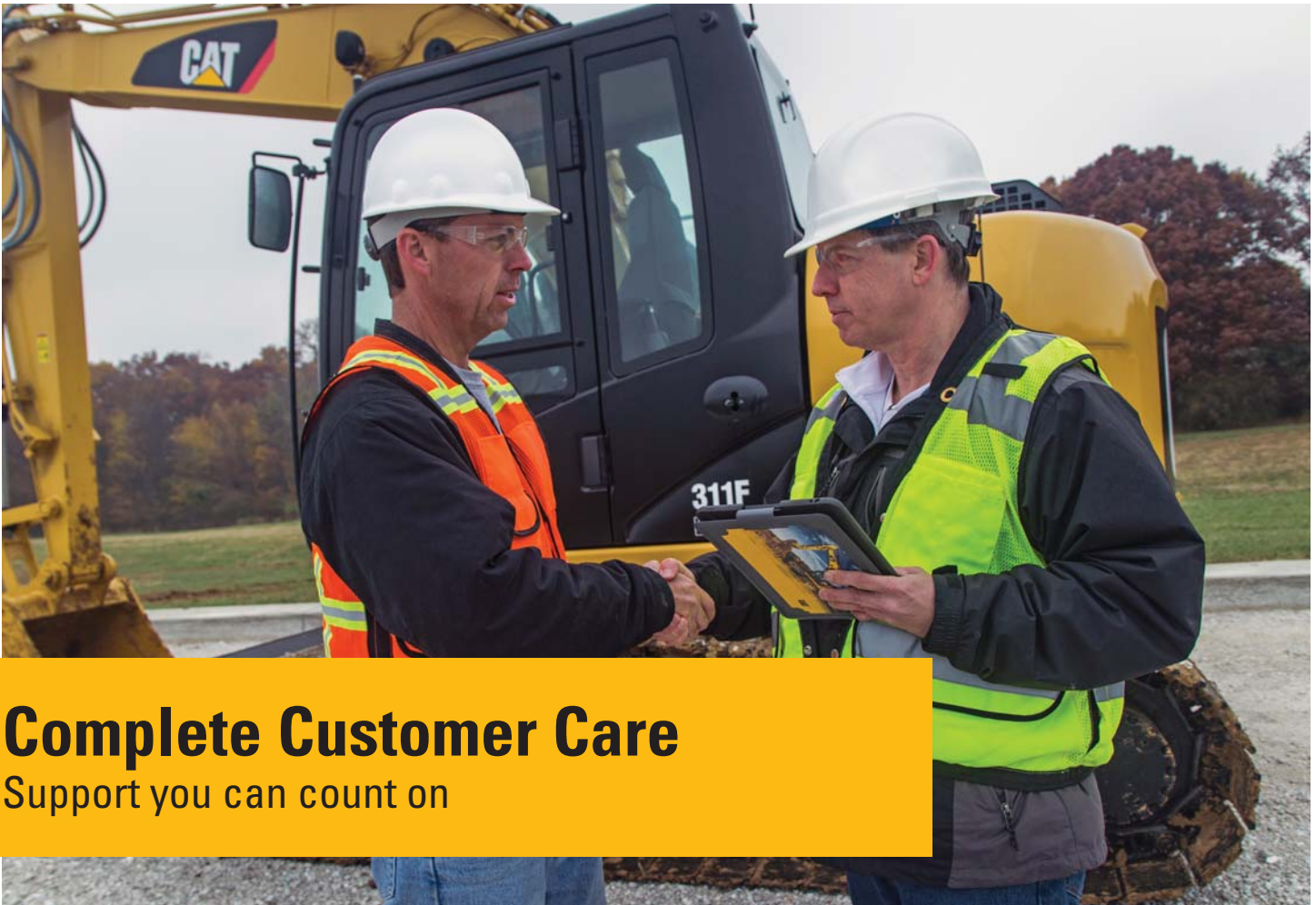

Complete Customer Care

Support you can count on

Worldwide Parts Availability

Cat dealers utilize a worldwide parts network to maximize your machines' uptime. Plus they can help you save money with Cat remanufactured components.

Advice You Can Trust

What are the job requirements and machine attachments? What production is needed? Your Cat dealer can provide recommendations to help you make the right machine choices.

Financial Options Just for You

Consider financing options and day-to-day operating costs. Look at dealer services that can be included in the machine's cost to yield lower owning and operating costs over time.

Support Agreements to Fit Your Needs

Cat dealers offer a variety of customer support agreements and work with you to develop a plan to meet your specific needs. These plans can cover the entire machine, including attachments, to help protect your investment.

Operating Techniques to Boost Your Profits

Improving operating techniques can boost your profits. Your Cat dealer has videos, literature, and other ideas to help you increase productivity. Caterpillar also offers simulators and certified operator training to help maximize the return on your investment.

What's Best for You Today...and Tomorrow

Repair, rebuild, or replace? Your Cat dealer can help you evaluate the cost involved so you can make the best choice for your business.



Sustainability

Generations ahead in every way

- The C3.4B engine meets Tier 4 Final, Stage IIIB, and Japan 2014 (Tier 4 Final) emission standards.
- The 311F L RR performs a similar amount of work while consuming less fuel than the previous D Series model. This means more efficiency, less resources consumed, and fewer emissions.
- The 311F has the flexibility of running on either ultra-low-sulfur diesel (ULSD) fuel with 15 ppm of sulfur or less or biodiesel (up to B20) fuel blended with ULSD that meets ASTM 6751 standards.
- An overfill indicator rises when the fuel tank is full to help service technicians avoid spilling.
- The 311F L RR is built to be rebuilt with major structures and components capable of being remanufactured to reduce waste and replacement costs.
- An efficient engine oil filter eliminates the need for painted metal cans and aluminum top plates. The cartridge-style spin-on housing enables the internal filter to be separated and replaced; the used internal element can be incinerated to help reduce waste.
- The 311F is an efficient, productive machine that's designed to conserve our natural resources for the generations ahead.

311F L RR Hydraulic Excavator Specifications

Engine

Engine Power – ISO 14396	55 kW	74 hp
Net Power – SAE J1349/ISO 9249	52 kW	70 hp
Bore	99 mm	3.90 in
Stroke	110 mm	4.33 in
Displacement	3.4 L	207 in ³

Hydraulic System

Main System – Maximum Flow (Total)	125 × 2 L/min	33 × 2 gal/min
Maximum Pressure – Equipment	30.5 MPa	4,424 psi
Maximum Pressure – Travel	35 MPa	5,076 psi
Maximum Pressure – Swing	23 MPa	3,336 psi
Pilot System – Maximum Flow	21.9 L/min	1,336 in ³ /min
Pilot System – Maximum Pressure	4120 kPa	598 psi
Boom Cylinder – Bore	100 mm	4 in
Boom Cylinder – Stroke	1002 mm	39 in
Stick Cylinder – Bore	110 mm	4 in
Stick Cylinder – Stroke	1194 mm	47 in
Bucket Cylinder – Bore	100 mm	4 in
Bucket Cylinder – Stroke	939 mm	37 in

Drive

Maximum Travel Speed – High	5.4 km/h	3.4 mph
Maximum Travel Speed – Low	3.6 km/h	2.2 mph
Maximum Drawbar Pull	114.3 kN	25,696 lb

Swing

Swing Speed	10 rpm	10 rpm
Swing Torque	30.9 kN·m	22,791 lbf-ft

Service Refill Capacities

Fuel Tank Capacity	210 L	55.48 gal
Cooling System	18 L	4.76 gal
Engine Oil (with filter)	8 L	2.1 gal
Swing Drive (each)	3 L	0.79 gal
Final Drive (each)	3 L	0.79 gal
Hydraulic System (including tank)	160 L	42.3 gal
Hydraulic Tank	95 L	25.1 gal

Track

Number of Shoes (each side)	43 pieces	43 pieces
Number of Track Rollers (each side)	6 pieces	6 pieces
Number of Carrier Rollers (each side)	1 piece	1 piece

Sound

ISO 6396		
Operator Noise (Closed)	72 dB(A)	72 dB(A)
ISO 6395		
Spectator Noise	99 dB(A)	99 dB(A)

311F L RR Hydraulic Excavator Specifications

Dimensions

All dimensions are approximate.

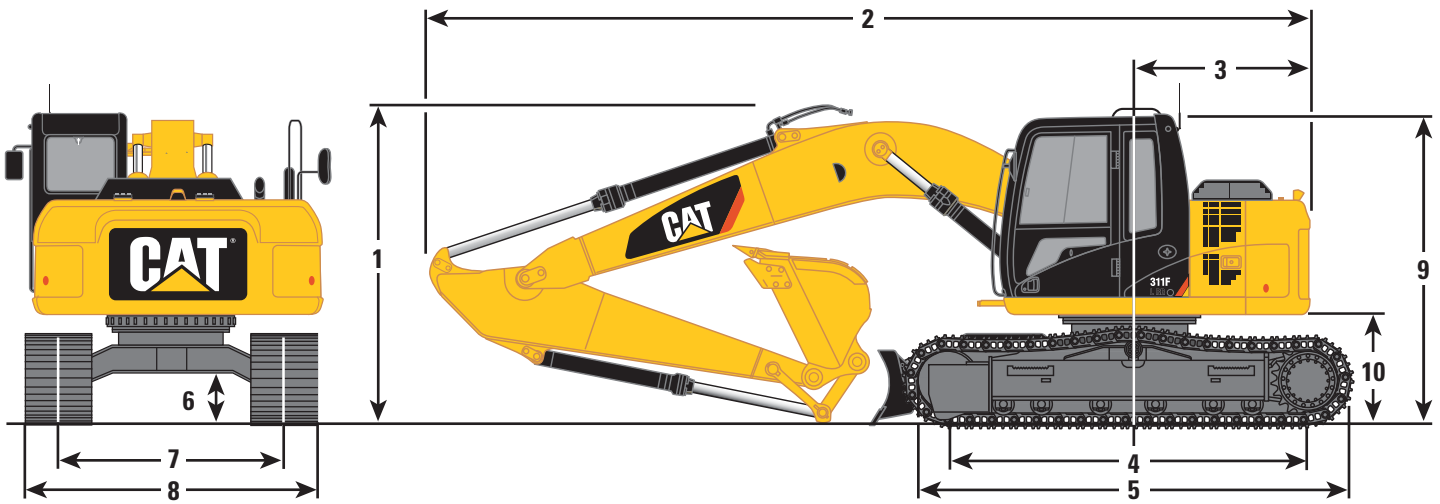

Stick	Reach Boom 4.3 m (14'1")			
	R2.25 m (7'5")		R2.8 m (9'2")	
1 Shipping Height*	2860 mm	9'5"	2820 mm	9'3"
Shipping Height at Boom Top	2860 mm	9'5"	2760 mm	9'1"
Handrail Height	2820 mm	9'3"	2820 mm	9'3"
2 Shipping Length				
Long Undercarriage	6920 mm	22'8"	6910 mm	22'8"
Long Undercarriage with Blade	7540 mm	24'9"	7530 mm	24'8"
3 Tail Swing Radius	1750 mm	5'9"	1750 mm	5'9"
4 Length to Center of Rollers	2780 mm	9'1"	2780 mm	9'1"
5 Track Length	3490 mm	11'5"	3490 mm	11'5"
6 Ground Clearance	440 mm	1'5"	440 mm	1'5"
7 Track Gauge	1990 mm	6'6"	1990 mm	6'6"
8 Transport Width				
500 mm (20") Shoes	2490 mm	8'2"	2490 mm	8'2"
600 mm (24") Shoes	2590 mm	8'6"	2590 mm	8'6"
700 mm (28") Shoes	2690 mm	8'10"	2690 mm	8'10"
770 mm (30") Shoes	2760 mm	9'1"	2760 mm	9'1"
9 Cab Height	2760 mm	9'1"	2760 mm	9'1"
Cab Height with Top Guard	2900 mm	9'6"	2900 mm	9'6"
10 Counterweight Clearance**	910 mm	3'0"	910 mm	3'0"
Type	GD		GD	
Capacity	0.53 m ³	0.69 yd ³	0.53 m ³	0.69 yd ³
Tip Radius	1230 mm	4'0"	1230 mm	4'0"

Notes: All dimensions based on bucket A (see table).

*Including shoe lug height.

**Without shoe lug height.

311F L RR Hydraulic Excavator Specifications

Working Ranges

All dimensions are approximate.

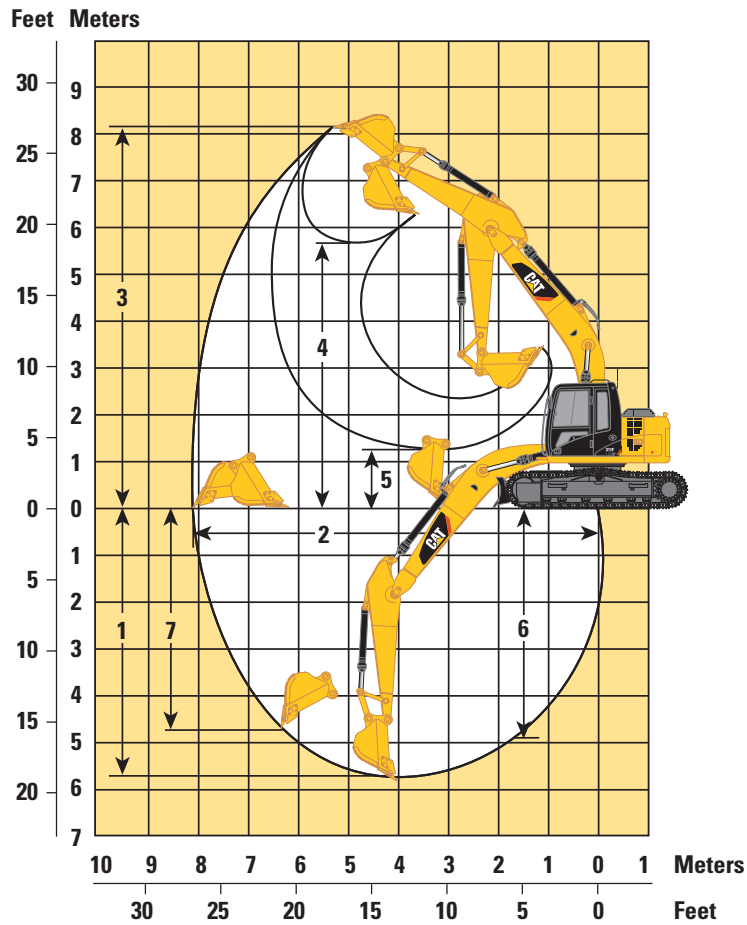

Stick	Reach Boom 4.3 m (14'1")			
	R2.25 m (7'5")		R2.8 m (9'2")	
1 Maximum Digging Depth	5040 mm	16'6"	5590 mm	18'4"
2 Maximum Reach at Ground Level	7570 mm	24'10"	8100 mm	26'7"
3 Maximum Cutting Height	7820 mm	25'8"	8140 mm	26'8"
4 Maximum Loading Height	5440 mm	17'10"	5770 mm	18'11"
5 Minimum Loading Height	1870 mm	6'2"	1330 mm	4'4"
6 Maximum Depth Cut for 2440 mm (8'0") Level Bottom	4330 mm	14'2"	4990 mm	16'4"
7 Maximum Vertical Wall Digging Depth	4360 mm	14'4"	4880 mm	16'0"
Type	GD		GD	
Capacity	0.53 m ³	0.69 yd ³	0.53 m ³	0.69 yd ³
Tip Radius	1230 mm	4'0"	1230 mm	4'0"

311F L RR Hydraulic Excavator Specifications

Blade

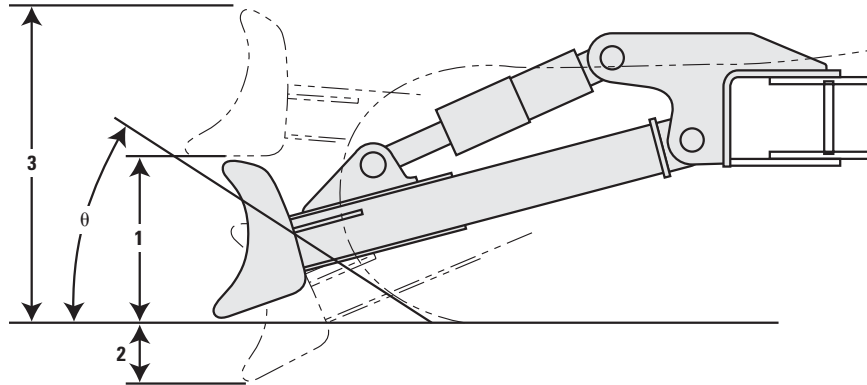

Blade Options	2500 mm (8'2")	2600 mm (8'6")	2700 mm (8'10")
Recommended Track Shoe Width	500 mm (20")	600 mm (24")	700 mm (28")
1 Blade Height		630 mm (2'1")	
2 Maximum Lowering Depth from Ground		570 mm (1'10")	
3 Maximum Raising Height above Ground		1000 mm (3'3")	
Approach Angle		23 degrees	

Major Component Weights

Base Machine (with boom cylinder, without counterweight, front linkage and track)	4050 kg	8,930 lb
Long Undercarriage	2430 kg	5,360 lb
Counterweight (2.45 mt/5,400 lb)	2450 kg	5,400 lb
Boom (includes lines, pins and stick cylinder)		
Reach Boom (4.3 m/14'1")	930 kg	2,050 lb
Stick (includes lines, pins and bucket cylinder)		
R2.25 m (7'5")	530 kg	1,170 lb
R2.8 m (9'2")	610 kg	1,350 lb
Track Shoe (long/per two track)		
500 mm (20") Triple Grouser	1460 kg	3,220 lb
600 mm (24") Triple Grouser	1700 kg	3,750 lb
700 mm (28") Triple Grouser	1960 kg	4,320 lb
770 mm (30") Triple Grouser	2100 kg	4,630 lb
Quick Coupler		
Center-Lock™ with Pin	480 kg	1,060 lb
Blade		
2500 mm (8'2")	810 kg	1,790 lb
2600 mm (8'6")	810 kg	1,790 lb
2700 mm (8'10")	820 kg	1,810 lb

All weights are rounded up to nearest 10 kg and lb. Kg and lb were rounded up separately so some of the kg and lb do not match.

Base machine includes 75 kg (165 lb) operator weight and 90% fuel weight.

311F L RR Hydraulic Excavator Specifications

Operating Weights and Ground Pressures

	770 mm (30") Triple Grouser Shoes				700 mm (28") Triple Grouser Shoes				600 mm (24") Triple Grouser Shoes				500 mm (20") Triple Grouser Shoes			
	kg	lb	kPa	psi	kg	lb	kPa	psi	kg	lb	kPa	psi	kg	lb	kPa	psi
Long Undercarriage without Blade																
Reach Boom – 4.65 m (14'1")																
R2.25 m (7'5")	13 000	28,700	27.3	4.0	12 900	28,400	29.8	4.3	12 600	27,800	34.0	4.9	12 400	27,300	40.1	5.8
R2.8 m (9'2")	13 100	28,900	27.5	4.0	12 900	28,400	29.8	4.3	12 700	28,000	34.2	5.0	12 500	27,600	40.4	5.9
Long Undercarriage with Blade																
Reach Boom – 4.65 m (14'1")																
R2.25 m (7'5")	13 800	30,400	29.0	4.2	13 700	30,200	31.7	4.6	13 400	29,500	36.1	5.2	13 200	29,100	42.7	6.2
R2.8 m (9'2")	13 900	30,600	29.2	4.2	13 800	30,400	31.9	4.6	13 500	29,800	36.4	5.3	13 300	29,300	43.0	6.2









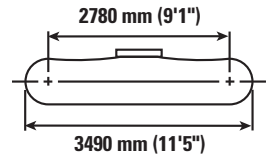
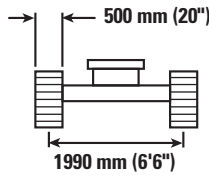
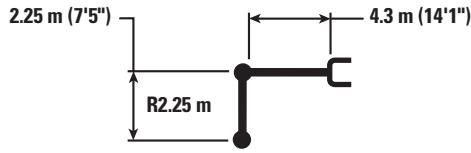

Bucket and Stick Forces

Pin On	Reach Boom 4.3 m (14'1")			
	R2.25 m (7'5")		R2.8 m (9'2")	
General Duty				
Bucket Digging Force (ISO)	89 kN		20,000 lb	
Stick Digging Force (ISO)	60 kN		13,500 lb	
Bucket Digging Force (SAE)	79 kN		17,900 lb	
Stick Digging Force (SAE)	58 kN		13,100 lb	
Heavy Duty				
Bucket Digging Force (ISO)	89 kN		20,000 lb	
Stick Digging Force (ISO)	60 kN		13,500 lb	
Bucket Digging Force (SAE)	79 kN		17,900 lb	
Stick Digging Force (SAE)	58 kN		13,100 lb	
Severe Duty				
Bucket Digging Force (ISO)	89 kN		19,900 lb	
Stick Digging Force (ISO)	60 kN		13,500 lb	
Bucket Digging Force (SAE)	77 kN		17,300 lb	
Stick Digging Force (SAE)	58 kN		13,000 lb	

311F L RR Hydraulic Excavator Specifications

Reach Boom Lift Capacities – Counterweight: 2.45 mt (5,400 lb) – No Blade



		1.5 m/5 ft		3 m/10 ft		4.5 m/15 ft		6 m/20 ft				mm in
												
6 m 20 ft	kg lb					*2350	*2350			*2100 *4,700	*2100 *4,700	4560 180
4.5 m 15 ft	kg lb					*3150 *6,900	*3150 *6,900			*1900 *4,150	*1900 *4,150	5700 230
3 m 10 ft	kg lb			*4800 *10,350	*4800 *10,350	*3700 *8,000	3100 6,650	2800 6,000	2000 4,250	*1850 *4,050	1850 4,050	6290 250
1.5 m 5 ft	kg lb			*6900 *14,800	5250 11,300	4200 9,050	2900 6,250	2750 5,850	1900 4,100	*1950 *4,250	1700 3,750	6480 260
0 m 0 ft	kg lb			*7750 *16,800	4950 10,650	4050 8,700	2750 5,900	2650 5,750	1850 4,000	*2200 *4,800	1750 3,800	6320 250
-1.5 m -5 ft	kg lb	*5550 *12,400	*5550 *12,400	*7500 *16,250	4950 10,550	4000 8,600	2700 5,800			*2750 *6,050	1950 4,300	5760 230
-3 m -10 ft	kg lb	*9950	*9950	*6250 *13,450	5050 10,800	*4050 *8,500	2750 6,000			*3800 *8,300	2650 5,900	4680 190



ISO 10567



*Indicates that the load is limited by hydraulic lifting capacity rather than tipping load. The above loads are in compliance with hydraulic excavator lift capacity standard ISO 10567:2007. They do not exceed 87% of hydraulic lifting capacity or 75% of tipping load. Weight of all lifting accessories must be deducted from the above lifting capacities. Lifting capacities are based on the machine standing on a firm, uniform supporting surface. The use of a work tool attachment point to handle/lift objects, could affect the machine lift performance.









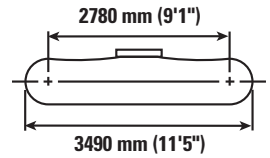
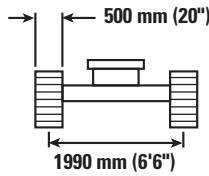
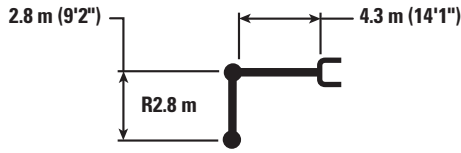

Lift capacity stays with ±5% for all available track shoes.

Always refer to the appropriate Operation and Maintenance Manual for specific product information.

311F L RR Hydraulic Excavator Specifications

Reach Boom Lift Capacities – Counterweight: 2.45 mt (5,400 lb) – No Blade



		1.5 m/5 ft		3 m/10 ft		4.5 m/15 ft		6 m/20 ft				mm in
												
6 m 20 ft	kg lb									*1650 *3,600	*1650 *3,600	5280 210
4.5 m 15 ft	kg lb							*2300 *4,350	2050 4,350	*1500 *3,250	*1500 *3,250	6290 250
3 m 10 ft	kg lb					*3250 *7,050	3150 6,750	2800 6,050	2000 4,250	*1450 *3,200	*1450 *3,200	6830 270
1.5 m 5 ft	kg lb			*6100 *13,150	5350 11,550	*4100 *8,800	2900 6,250	2750 5,850	1900 4,100	*1550 *3,350	1500 3,300	7010 280
0 m 0 ft	kg lb			*7500 *16,150	4950 10,650	4050 8,700	2750 5,900	2650 5,650	1850 3,900	*1700 *3,700	1500 3,300	6850 270
-1.5 m -5 ft	kg lb	*4800 *10,700	*4800 *10,700	*7650 *16,550	4850 10,350	3950 8,450	2650 5,700	2600 5,600	1800 3,850	*2050 *4,500	1650 3,650	6350 250
-3 m -10 ft	kg lb	*7950 *17,900	*7950 *17,900	*6850 *14,700	4900 10,500	3950 8,500	2650 5,750			*2850 *6,400	2100 4,700	5380 210



ISO 10567



*Indicates that the load is limited by hydraulic lifting capacity rather than tipping load. The above loads are in compliance with hydraulic excavator lift capacity standard ISO 10567:2007. They do not exceed 87% of hydraulic lifting capacity or 75% of tipping load. Weight of all lifting accessories must be deducted from the above lifting capacities. Lifting capacities are based on the machine standing on a firm, uniform supporting surface. The use of a work tool attachment point to handle/lift objects, could affect the machine lift performance.









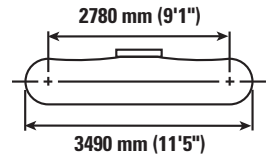
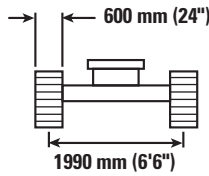
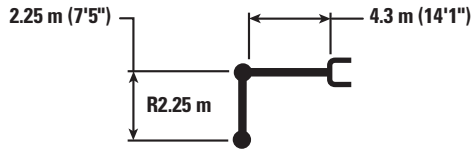

Lift capacity stays with ±5% for all available track shoes.

Always refer to the appropriate Operation and Maintenance Manual for specific product information.

311F L RR Hydraulic Excavator Specifications

Reach Boom Lift Capacities – Counterweight: 2.45 mt (5,400 lb) – No Blade



		1.5 m/5 ft		3 m/10 ft		4.5 m/15 ft		6 m/20 ft				mm in
												
6 m 20 ft	kg lb					*2350	*2350			*2100 *4,700	*2100 *4,700	4560 180
4.5 m 15 ft	kg lb					*3150 *6,900	*3150 *6,900			*1900 *4,150	*1900 *4,150	5700 230
3 m 10 ft	kg lb			*4800 *10,350	*4800 *10,350	*3700 *8,000	3150 6,750	2850 6,100	2000 4,300	*1850 *4,050	*1850 *4,050	6290 250
1.5 m 5 ft	kg lb			*6900 *14,800	5350 11,500	4300 9,200	2950 6,350	2800 5,950	1950 4,200	*1950 *4,250	1750 3,800	6480 260
0 m 0 ft	kg lb			*7750 *16,800	5050 10,850	4150 8,900	2800 6,050	2700 5,850	1900 4,050	*2200 *4,800	1750 3,850	6320 250
-1.5 m -5 ft	kg lb	*5550 *12,400	*5550 *12,400	*7500 *16,250	5000 10,750	4100 8,750	2750 5,950			*2750 *6,050	2000 4,400	5760 230
-3 m -10 ft	kg lb	*9950	*9950	*6250 *13,450	5100 11,000	*4050 *8,500	2850 6,100			*3800 *8,300	2700 6,000	4680 190



ISO 10567



*Indicates that the load is limited by hydraulic lifting capacity rather than tipping load. The above loads are in compliance with hydraulic excavator lift capacity standard ISO 10567:2007. They do not exceed 87% of hydraulic lifting capacity or 75% of tipping load. Weight of all lifting accessories must be deducted from the above lifting capacities. Lifting capacities are based on the machine standing on a firm, uniform supporting surface. The use of a work tool attachment point to handle/lift objects, could affect the machine lift performance.









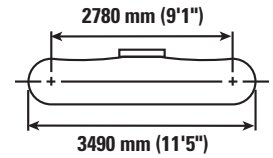
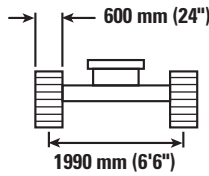
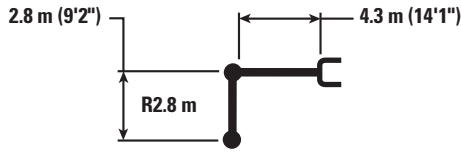

Lift capacity stays with ±5% for all available track shoes.

Always refer to the appropriate Operation and Maintenance Manual for specific product information.

311F L RR Hydraulic Excavator Specifications

Reach Boom Lift Capacities – Counterweight: 2.45 mt (5,400 lb) – No Blade



		1.5 m/5 ft		3 m/10 ft		4.5 m/15 ft		6 m/20 ft				mm in
												
6 m 20 ft	kg lb									*1650 *3,600	*1650 *3,600	5280 210
4.5 m 15 ft	kg lb							*2300 *4,350	2100 *4,350	*1500 *3,250	*1500 *3,250	6290 250
3 m 10 ft	kg lb					*3250 *7,050	3200 6,850	2900 6,150	2050 4,350	*1450 *3,200	*1450 *3,200	6830 270
1.5 m 5 ft	kg lb			*6100 *13,150	5450 11,750	*4100 *8,800	3000 6,400	2800 5,950	1950 4,150	*1550 *3,350	*1550 *3,350	7010 280
0 m 0 ft	kg lb			*7500 *16,150	5050 10,850	4100 8,850	2800 6,000	2700 5,800	1850 4,000	*1700 *3,700	1550 3,400	6850 270
-1.5 m -5 ft	kg lb	*4800 *10,700	*4800 *10,700	*7650 *16,550	4950 10,550	4050 8,650	2700 5,800	2650 5,700	1850 3,900	*2050 *4,500	1700 3,750	6350 250
-3 m -10 ft	kg lb	*7950 *17,900	*7950 *17,900	*6850 *14,700	5000 10,700	4050 8,700	2700 5,850			*2850 *6,400	2150 4,800	5380 210



ISO 10567



*Indicates that the load is limited by hydraulic lifting capacity rather than tipping load. The above loads are in compliance with hydraulic excavator lift capacity standard ISO 10567:2007. They do not exceed 87% of hydraulic lifting capacity or 75% of tipping load. Weight of all lifting accessories must be deducted from the above lifting capacities. Lifting capacities are based on the machine standing on a firm, uniform supporting surface. The use of a work tool attachment point to handle/lift objects, could affect the machine lift performance.









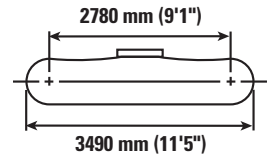
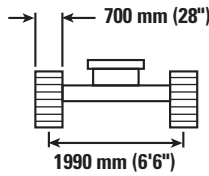
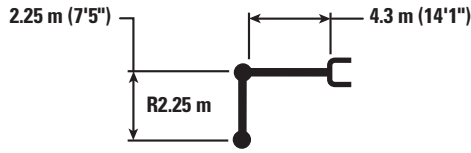

Lift capacity stays with ±5% for all available track shoes.

Always refer to the appropriate Operation and Maintenance Manual for specific product information.

311F L RR Hydraulic Excavator Specifications

Reach Boom Lift Capacities – Counterweight: 2.45 mt (5,400 lb) – No Blade



		1.5 m/5 ft		3 m/10 ft		4.5 m/15 ft		6 m/20 ft				mm in
												
6 m 20 ft	kg lb					*2350	*2350			*2100	*2100	4560 180
4.5 m 15 ft	kg lb					*3150	*3150			*1900	*1900	5700 230
3 m 10 ft	kg lb			*4800	*4800	*3700	3200	2900	2050	*1850	*1850	6290 250
1.5 m 5 ft	kg lb			*6900	5450	4400	3000	2850	2000	*1950	1800	6480 260
0 m 0 ft	kg lb			*7750	5150	4200	2850	2800	1950	*2200	1800	6320 250
-1.5 m -5 ft	kg lb	*5550	*5550	*7500	5150	4150	2800			*2750	2050	5760 230
-3 m -10 ft	kg lb	*9950	*9950	*6250	5250	*4050	2900			*3800	2750	4680 190



ISO 10567



*Indicates that the load is limited by hydraulic lifting capacity rather than tipping load. The above loads are in compliance with hydraulic excavator lift capacity standard ISO 10567:2007. They do not exceed 87% of hydraulic lifting capacity or 75% of tipping load. Weight of all lifting accessories must be deducted from the above lifting capacities. Lifting capacities are based on the machine standing on a firm, uniform supporting surface. The use of a work tool attachment point to handle/lift objects, could affect the machine lift performance.









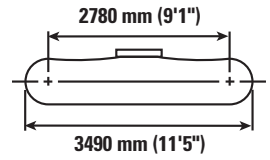
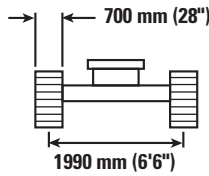
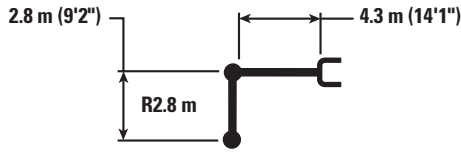

Lift capacity stays with ±5% for all available track shoes.

Always refer to the appropriate Operation and Maintenance Manual for specific product information.

311F L RR Hydraulic Excavator Specifications

Reach Boom Lift Capacities – Counterweight: 2.45 mt (5,400 lb) – No Blade



		1.5 m/5 ft		3 m/10 ft		4.5 m/15 ft		6 m/20 ft				mm in
												
6 m 20 ft	kg lb									*1650 *3,600	*1650 *3,600	5280 210
4.5 m 15 ft	kg lb							*2300 *4,350	2100 *4,350	*1500 *3,250	*1500 *3,250	6290 250
3 m 10 ft	kg lb					*3250 *7,050	3250 7,000	2950 6,300	2050 4,450	*1450 *3,200	*1450 *3,200	6830 270
1.5 m 5 ft	kg lb			*6100 *13,150	5550 12,000	*4100 *8,800	3050 6,500	2850 6,100	2000 4,250	*1550 *3,350	*1550 *3,350	7010 280
0 m 0 ft	kg lb			*7500 *16,150	5150 11,050	4200 9,050	2850 6,150	2750 5,900	1900 4,100	*1700 *3,700	1600 3,450	6850 270
-1.5 m -5 ft	kg lb	*4800 *10,700	*4800 *10,700	*7650 *16,550	5050 10,800	4100 8,800	2750 5,950	2700 5,850	1850 4,000	*2050 *4,500	1750 3,800	6350 250
-3 m -10 ft	kg lb	*7950 *17,900	*7950 *17,900	*6850 *14,700	5100 10,900	4150 8,850	2800 6,000			*2850 *6,400	2200 4,900	5380 210



ISO 10567



*Indicates that the load is limited by hydraulic lifting capacity rather than tipping load. The above loads are in compliance with hydraulic excavator lift capacity standard ISO 10567:2007. They do not exceed 87% of hydraulic lifting capacity or 75% of tipping load. Weight of all lifting accessories must be deducted from the above lifting capacities. Lifting capacities are based on the machine standing on a firm, uniform supporting surface. The use of a work tool attachment point to handle/lift objects, could affect the machine lift performance.









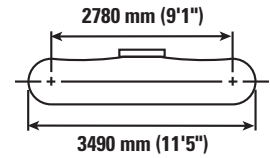
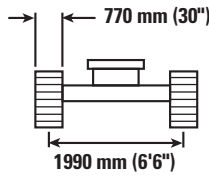
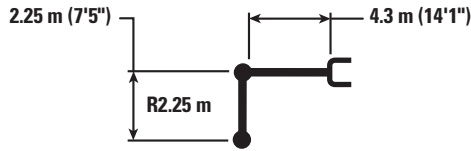

Lift capacity stays with ±5% for all available track shoes.

Always refer to the appropriate Operation and Maintenance Manual for specific product information.

311F L RR Hydraulic Excavator Specifications

Reach Boom Lift Capacities – Counterweight: 2.45 mt (5,400 lb) – No Blade



		1.5 m/5 ft		3 m/10 ft		4.5 m/15 ft		6 m/20 ft				mm in
												
6 m 20 ft	kg lb					*2350	*2350			*2100	*2100	4560 180
4.5 m 15 ft	kg lb					*3150	*3150			*1900	*1900	5700 230
3 m 10 ft	kg lb			*4800	*4800	*3700	3250	2950	2100	*1850	*1850	6290 250
1.5 m 5 ft	kg lb			*6900	5500	4450	3050	2900	2000	*1950	1800	6480 260
0 m 0 ft	kg lb			*7750	5200	4250	2900	2800	1950	*2200	1850	6320 250
-1.5 m -5 ft	kg lb	*5550	*5550	*7500	5200	4200	2850			*2750	2050	5760 230
-3 m -10 ft	kg lb	*9950	*9950	*6250	5300	*4050	2900			*3800	2800	4680 190



ISO 10567



*Indicates that the load is limited by hydraulic lifting capacity rather than tipping load. The above loads are in compliance with hydraulic excavator lift capacity standard ISO 10567:2007. They do not exceed 87% of hydraulic lifting capacity or 75% of tipping load. Weight of all lifting accessories must be deducted from the above lifting capacities. Lifting capacities are based on the machine standing on a firm, uniform supporting surface. The use of a work tool attachment point to handle/lift objects, could affect the machine lift performance.









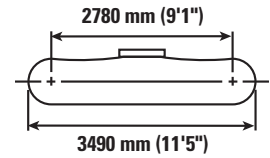
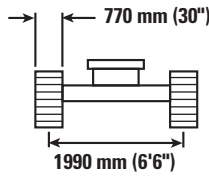
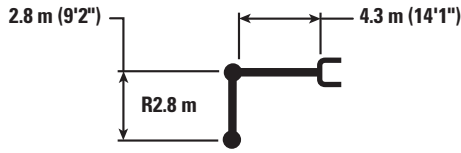

Lift capacity stays with ±5% for all available track shoes.

Always refer to the appropriate Operation and Maintenance Manual for specific product information.

311F L RR Hydraulic Excavator Specifications

Reach Boom Lift Capacities – Counterweight: 2.45 mt (5,400 lb) – No Blade



		1.5 m/5 ft		3 m/10 ft		4.5 m/15 ft		6 m/20 ft				
												mm in
6 m 20 ft	kg lb									*1650 *3,600	*1650 *3,600	5280 210
4.5 m 15 ft	kg lb							*2300 *4,350	2150 *4,350	*1500 *3,250	*1500 *3,250	6290 250
3 m 10 ft	kg lb					*3250 *7,050	*3250 7,050	2950 6,350	2100 4,500	*1450 *3,200	*1450 *3,200	6830 270
1.5 m 5 ft	kg lb			*6100 *13,150	5650 12,100	*4100 *8,800	3050 6,600	2850 6,150	2000 4,300	*1550 *3,350	*1550 *3,350	7010 280
0 m 0 ft	kg lb			*7500 *16,150	5200 11,200	4250 9,150	2900 6,200	2800 5,950	1950 4,150	*1700 *3,700	1600 3,500	6850 270
-1.5 m -5 ft	kg lb	*4800 *10,700	*4800 *10,700	*7650 *16,550	5100 10,900	4150 8,900	2800 6,000	2750 5,900	1900 4,050	*2050 *4,500	1750 3,850	6350 250
-3 m -10 ft	kg lb	*7950 *17,900	*7950 *17,900	*6850 *14,700	5150 11,050	4200 8,950	2800 6,050			*2850 *6,400	2250 4,950	5380 210



ISO 10567



*Indicates that the load is limited by hydraulic lifting capacity rather than tipping load. The above loads are in compliance with hydraulic excavator lift capacity standard ISO 10567:2007. They do not exceed 87% of hydraulic lifting capacity or 75% of tipping load. Weight of all lifting accessories must be deducted from the above lifting capacities. Lifting capacities are based on the machine standing on a firm, uniform supporting surface. The use of a work tool attachment point to handle/lift objects, could affect the machine lift performance.

Lift capacity stays with ±5% for all available track shoes.

Always refer to the appropriate Operation and Maintenance Manual for specific product information.

311F L RR Hydraulic Excavator Specifications

311F L RR Work Tool Offering Guide*

Boom Type	Reach Boom	
	R2.25 m (7'5")	R2.8 m (9'2")
Hydraulic Hammer	H95Es H110Es	H95Es H110Es**
Demolition and Sorting Grapple	G310B**	NA
Mobile Scrap and Demolition Shear	NA	NA
Compactor (Vibratory Plate)	CVP75	CVP75
Contractors' Grapple	G112B	G112B
Orange Peel Grapple		
Trash Grapple		
Thumbs		
Rakes		
Center-Lock Pin Grabber Coupler		
Dedicated Quick Coupler		

These work tools are available for the 311F L RR.
Consult your Cat dealer for proper match.

*Offerings not available in all areas. Maximum weight limitation for ROPS certification is (14 712 kg/32,440 lb). Matches are dependent on excavator configurations. Consult your Cat dealer to determine what is offered in your area, and, for proper work tool match.

**Pin on only.

311F L RR Hydraulic Excavator Specifications

Bucket Specifications and Compatibility

	Width		Capacity		Weight		Fill %	Reach Booms – No Blade Installed							
	mm	in	m ³	yd ³	kg	lb		500 mm (20") TG		600 mm (24") TG		700 mm (28") TG		770 mm (30") TG	
								2.25 m (7'5")	2.8 m (9'2")	2.25 m (7'5")	2.8 m (9'2")	2.25 m (7'5")	2.8 m (9'2")	2.25 m (7'5")	2.8 m (9'2")
With Center-Lock Quick Coupler															
General Duty (GD)	450	18	0.20	0.27	235	518	100	●	●	●	●	●	●	●	●
	500	20	0.24	0.31	285	628	100	●	●	●	●	●	●	●	●
	600	24	0.31	0.40	308	679	100	●	●	●	●	●	●	●	●
	750	30	0.41	0.54	355	783	100	●	●	●	●	●	●	●	●
	900	36	0.53	0.69	404	890	100	●	⊖	●	⊙	●	⊙	●	⊙
	1050	42	0.65	0.84	452	996	100	⊖	○	⊙	○	⊙	○	⊙	⊖
	1200	48	0.76	1.00	492	1,084	100	○	◇	⊖	◇	⊖	○	⊖	○
Maximum load pin on (payload + bucket)							kg	1548	1292	1587	1328	1630	1366	1653	1388
							lb	3,412	2,848	3,498	2,927	3,593	3,011	3,644	3,060

	Width		Capacity		Weight		Fill %	Reach Booms – Blade Installed							
	mm	in	m ³	yd ³	kg	lb		500 mm (20") TG		600 mm (24") TG		700 mm (28") TG		770 mm (30") TG	
								2.25 m (7'5")	2.8 m (9'2")	2.25 m (7'5")	2.8 m (9'2")	2.25 m (7'5")	2.8 m (9'2")	2.25 m (7'5")	2.8 m (9'2")
With Center-Lock Quick Coupler															
General Duty (GD)	450	18	0.20	0.27	235	518	100	●	●	●	●#	●#	●#	●#	●#
	500	20	0.24	0.31	285	628	100	●	●	●	●#	●#	●#	●#	●#
	600	24	0.31	0.40	308	679	100	●	●	●	●#	●#	●#	●#	●#
	750	30	0.41	0.54	355	783	100	●	●	●#	●#	●#	●#	●#	●#
	900	36	0.53	0.69	404	890	100	●	⊙	●#	⊙#	●#	●#	●#	●#
	1050	42	0.65	0.84	452	996	100	⊙	⊖	⊙#	⊖#	●#	⊖#	●#	⊖#
	1200	48	0.76	1.00	492	1,084	100	⊖	○	⊖#	○#	⊖#	○#	⊖#	○#
Maximum load pin on (payload + bucket)							kg	1678	1410	1719	1447	1763	1488	1787	1509
							lb	3,699	3,108	3,789	3,190	3,886	3,280	3,939	3,326

The above loads are in compliance with hydraulic excavator standard EN474, they do not exceed 87% of hydraulic lifting capacity or 75% of tipping capacity with front linkage fully extended at ground line with bucket curled.

Capacity based on ISO 7451.

Bucket weight with long tips.

#Consult dealer for maximum weight limitation (14 712 kg/32,440 lb) of ROPS certification.

Maximum Material Density:

● 2100 kg/m³ (3,500 lb/yd³)

⊙ 1800 kg/m³ (3,000 lb/yd³)

⊖ 1500 kg/m³ (2,500 lb/yd³)

○ 1200 kg/m³ (2,000 lb/yd³)

◇ 900 kg/m³ (1,500 lb/yd³)

Caterpillar recommends using appropriate work tools to maximize the value customers receive from our products. Use of work tools, including buckets, which are outside of Caterpillar's recommendations or specifications for weight, dimensions, flows, pressures, etc. may result in less-than-optimal performance, including but not limited to reductions in production, stability, reliability, and component durability. Improper use of a work tool resulting in sweeping, prying, twisting and/or catching of heavy loads will reduce the life of the boom and stick.

Standard Equipment

Standard equipment may vary. Consult your Cat dealer for details.

CAB

- Pressurized operator station with positive filtration
- Sliding upper door window (left-hand cab door)
- Adjustable high-back, heated seat with air suspension
- Removable lower windshield with in cab storage bracket
- Coat hook
- Beverage holder
- Literature holder
- Radio Ready (24V)
- Two stereo speakers
- Storage shelf suitable for lunch or toolbox
- Color LCD display with indicators, filter/fluid change, and working hour information
- Adjustable armrest
- Height adjustable joystick consoles
- Neutral lever (lock out) for all controls
- Travel control pedals with removable hand levers
- Capability of installing additional pedal
- Two power outlets, 10 amp (total)
- Travel alarm
- Laminated glass front upper window and tempered other windows
- Level sensor

COUNTERWEIGHT

- Ashtray
- 2.45 mt (2.7 t) without lifting eye

ELECTRICAL

- 80 amp alternator
- Circuit breaker
- Capability to electrically connect a beacon

ENGINE

- C3.4B diesel engine
- Biodiesel capable
- Meets Tier 4 Final, Stage IIIB, and Japan 2014 (Tier 4 Final) emission standards
- 2300 m (7,500 ft) altitude capability
- Manual priming pump
- Automatic engine speed control
- Economy and high power modes
- Two-speed travel
- Side-by-side cooling system
- Radial seal air filter
- Primary filter with water separator and water separator indicator
- Secondary filter
- Standard battery –18° C (0° F)

HYDRAULIC SYSTEM

- Regeneration circuit for boom and stick
- Reverse swing dampening valve
- Automatic swing parking brake
- High-performance hydraulic return filter

LIGHTS

- Halogen boom light (left side)
- Time delay function for boom light and cab light
- Exterior light

UNDERCARRIAGE

- Center track guiding guard
- Grease Lubricated Track GLT2, resin seal
- Towing eye on base frame

SECURITY

- Cat one key security system
- Door locks
- Cap locks on fuel and hydraulic tanks
- Lockable external tool/storage box
- Signaling/warning horn
- Secondary engine shutoff switch
- Openable skylight for emergency exit
- Rearview camera

311F L RR Optional Equipment

Optional Equipment

Optional equipment may vary. Consult your Cat dealer for details.

CAB

- Straight travel pedal
- Sunscreen

ENGINE

- Jump start receptacle

FRONT LINKAGE

- Quick coupler
- Bucket linkage
- 4.3 m (14'1") reach boom
- 2.25 m (7'5") reach stick
- 2.8 m (9'2") reach stick

HYDRAULIC SYSTEM

- Control pattern quick-changer, two way
- Auxiliary hydraulics
- Boom and stick lines
- High-pressure line
- Medium-pressure line
- Quick coupler line
- Boom lowering and stick lowering control valve

SECURITY

- FOGS, bolt-on
- Guard, cab front, mesh
- Guard, vandalism
- Side steel bumper
- Security system fitted (MSS)
- Bottom guards, heavy duty

TECHNOLOGY

- Product Link

LIGHTS

- Working light, cab mounted with time delay
- Halogen boom lights (right side)

UNDERCARRIAGE

- 500 mm (20") triple grouser shoes
- 600 mm (24") triple grouser shoes
- 700 mm (28") triple grouser shoes
- 770 mm (30") triple grouser shoes
- Rubber pad for 500 mm (20") triple grouser shoes
- 2500 mm (8'2") blade with replaceable cutting edge
- 2600 mm (8'6") blade with replaceable cutting edge
- 2700 mm (8'10") blade with replaceable cutting edge
- Swivel guard
- Track guiding guard

For more complete information on Cat products, dealer services, and industry solutions, visit us on the web at www.cat.com

AEHQ7947
(AUZ)

© 2017 Caterpillar
All rights reserved

Materials and specifications are subject to change without notice. Featured machines in photos may include additional equipment. See your Cat dealer for available options.

CAT, CATERPILLAR, SAFETY.CAT.COM, their respective logos, "Caterpillar Yellow" and the "Power Edge" trade dress, as well as corporate and product identity used herein, are trademarks of Caterpillar and may not be used without permission.

VisionLink is a trademark of Trimble Navigation Limited, registered in the United States and in other countries.

