

521B/522B

Track Feller Bunchers & Track Harvesters
– ZTS (Zero Tail Swing)



Power Train

521B/522B

Engine Model	Cat® C9 ACERT™	
Gross Power	226 kW	303 hp

Operating Weights (without heads, standard counterweight)

Track Feller Buncher

521B	27 501 kg	60,629 lb
522B	32 528 kg	71,711 lb

Track Harvester Configuration

521B	26 966 kg	59,450 lb
522B	31 993 kg	70,532 lb

Cat 521B/522B Features

Power Train

The Cat C9 ACERT Tier 3 high torque engine provides excellent power, fuel economy, serviceability and durability. The Cat C9 ACERT is a dependable performer, while meeting all U.S. EPA emission standards.

Hydraulics

Closed Center hydraulic system with electronic programmable controls that produce excellent multi-function system uses; dedicated pilot, travel, implement and saw pumps.

Operator Comfort

The Cat purpose built forestry cab offers industry leading operator protection and comfort. Cab is designed and tested to meet 120% of machine operating weight, meets ROPS, FOPS, OPS, OR-OSHA and WCB regulations and standards. New ISO mounting system reduces noise and vibration, increasing operator comfort.

Leveling System

The Cat three (3) hydraulic cylinder tilting system is extremely durable and reliable, and is the only one in the industry to provide two way simultaneous function throughout the full range of tilting motion.

Undercarriage

The 521B/522B have a new D7 size undercarriage custom designed for reliable operation in tough harvesting conditions, from wet bottomlands to steep rocky slopes.

Contents

Power Train.....	4
Hydraulic Packages.....	5
Operator Station.....	6
Leveling System	7
Undercarriage	8
Boom and Stick	9
Attachments.....	9
Sustainability	10
Serviceability.....	11
Customer Support.....	12
Specifications	13
Standard Equipment	18
Optional Equipment.....	19





The new B Series track feller bunchers feature smoother hydraulic performance, increased engine HP, a more comfortable operator station and better right side operator visibility. Both the Cat 521B and the 522B Series are zero tail swing machines designed for medium to high production clear cut and or select cut on rough terrain. These machines perform in a variety of small through larger tree size applications. The 522B model is a leveling machine for more comfort on steep terrain.

A robust undercarriage utilizes proven components, customized for demanding forestry conditions. The unique boom design provides industry leading lift capacity throughout full reach range, a benefit in large timber. Two models are available with just the right horsepower, track size and hydraulic configurations to fit your application needs.

Power Train

Built for power, reliability, low maintenance, fuel efficiency and low emissions.

Powerful Performance

The Cat C9 electronically controlled ACERT engine delivers power while meeting all current U.S. EPA emission standards. All models contain a fuel/water separator, engine air intake heater and a dual-stage combination air cleaner with precleaner.

High Capacity Cooling System

The side-by-side radiator/oil cooler gives excellent cooling capacity for high production bunching and harvesting. On-demand Flexxaire fan activates only when required and allows the cooling fan to purge debris from the radiator area, keeping a cleaner cooling system. The IQAN control system automatically adjusts the Flexxaire fan blade angle, reducing horsepower demand and lowering fuel consumption. The purge cycle frequency and duration can be set by operator in the cab to suit varying application conditions.

Engine Oil

Cat engine oil is formulated to optimize engine life and performance and is recommended for use in Cat diesel engines. Extended oil change intervals reduce maintenance and machine downtime.

Service

The clamshell style engine compartment provides easy access to all filters, oil dipstick, coolant reservoir, hydraulic fill pump, valves and hoses reducing maintenance time.

Low Exhaust Emissions

The Cat C9 ACERT engine is a low emission engine designed to meet U.S. EPA emission regulations.

Batteries

An optional starting aid for colder climates is available for 521B/522B machine models. This option provides two (2) additional batteries and HD battery cables.

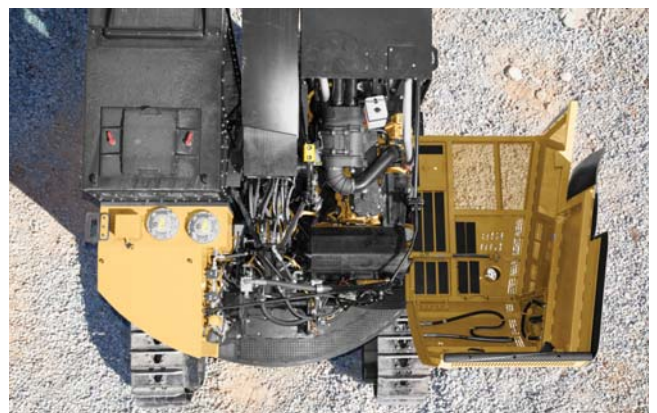

Hydraulic Packages

Powerful hydraulic system combined with a powerful boom and stick maximize productivity.



Electric Hydraulic Oil Fill Pump

An easy accessible service wand allows hydraulic oil to be pumped through the hydraulic filtering system and into the tank. This reduces maintenance downtime and helps to maintain oil cleanliness requirements.

Variable Displacement Pump

521B and 522B track feller bunchers are equipped with variable displacement pumps for travel and implement functions. A dedicated variable displacement pump is also available for Hot Saw and Intermittent Saw attachments. Optional hydraulics for dangle harvesting or processor heads are available for all models.

Valve Design Flexibility

Two hydraulic valve groups are available to allow configuration of machine to operate various felling heads. Valve designs allow maximizing of machine multi-functioning performance.

- 1) High flow felling heads requiring 170-190 L/min (45-50 gal/min) to the grab and accumulator arms. Typically have one cylinder operating each arm, two cylinders per arm set.
- 2) Low flow felling heads requiring 110-120 L/min (29-32 gal/min) to operate grab and accumulator arms. Typically one hydraulic cylinder and a link arm activate the arm set. Note: Consult the work tool manufacturer for flow requirements before selecting one of the above Hydraulic Arrangements.

Cat Hydraulic Oil

Provides maximum protection against mechanical and corrosive wear in all hydraulic systems. Its high zinc content reduces wear and extends pump life. Biodegradable hydraulic oil (HEES) is also available from your Cat dealer and provides an environmentally-sound alternative to mineral based oils.

ToughGuard™ Hoses

Abrasion resistant hoses along the boom and stick provide strength and flexibility. The ToughGuard cover consists of a thin layer of UHMW polyethylene bonded to the rubber cover, providing exceptional abrasion resistance.

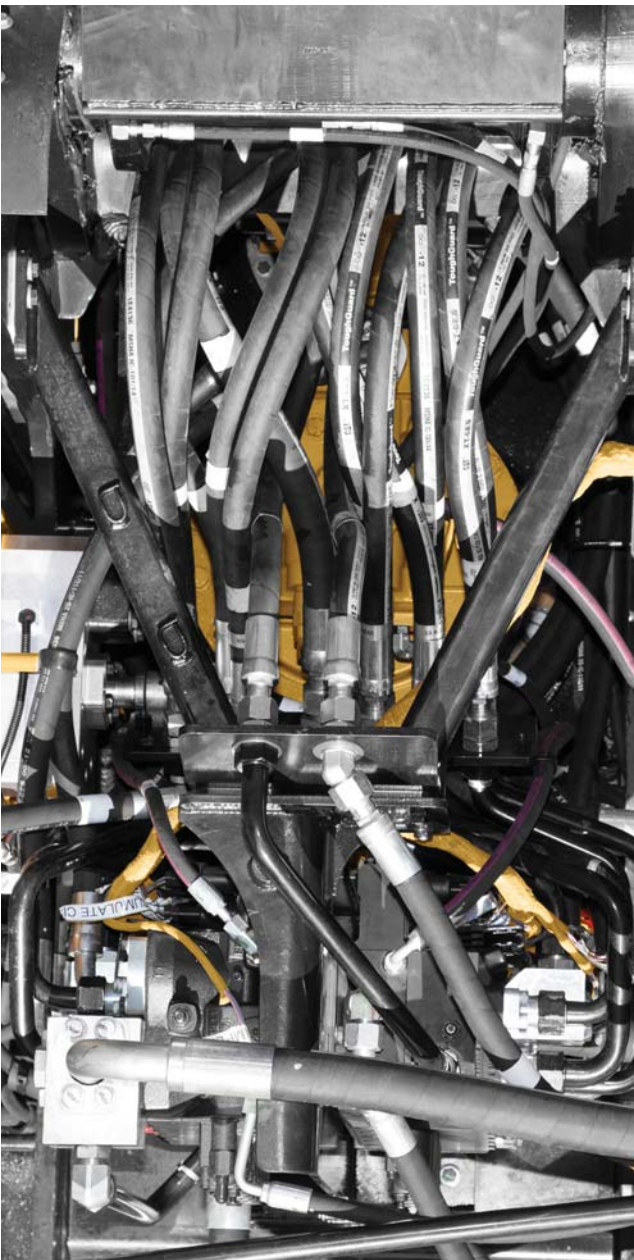

Operator Station

Superior comfort and visibility.

Operator Comfort

The operator station is designed with joysticks and an air ride seat, reducing operator fatigue and providing easy operation. An HVAC system with updated air ducts provides better cooling and heating. A large side window with side screen allows fresh air into the cab, and an isolated mounted cab and engine reduces noise levels and vibration. Ergonomically located pedals with side-by-side foot rests provide operator comfort while operating machine travel.

Visibility

The cab design optimizes post structures and window placement to provide excellent operator visibility to front, sides and rear. A large polycarbonate skylight provides excellent upward visibility.

Safety

The standard 32 mm (1.25 in) thick "Margard" front window maximizes operator protection. All purpose built forestry cabs meet FOPS/ROPS/OPS/WCB, OR-OSHA requirements. The skylight provides an alternate escape hatch.

Monitor

The IQAN MD3 display allows the operator to continuously monitor the operating system of the machine. The monitor has been downsized slightly to improve the operator's line of sight out the right front corner of the cab. The IQAN control system allows the operator to adjust all control parameters.

Electrical System

The B Series track feller bunchers feature dual in-cab 12 volt power points and one 24 volt power point. Power is provided by two 12 volt maintenance free batteries and 95 amp alternator. An optional cold weather starting attachment may be selected to provide two additional batteries and HD starter cables.

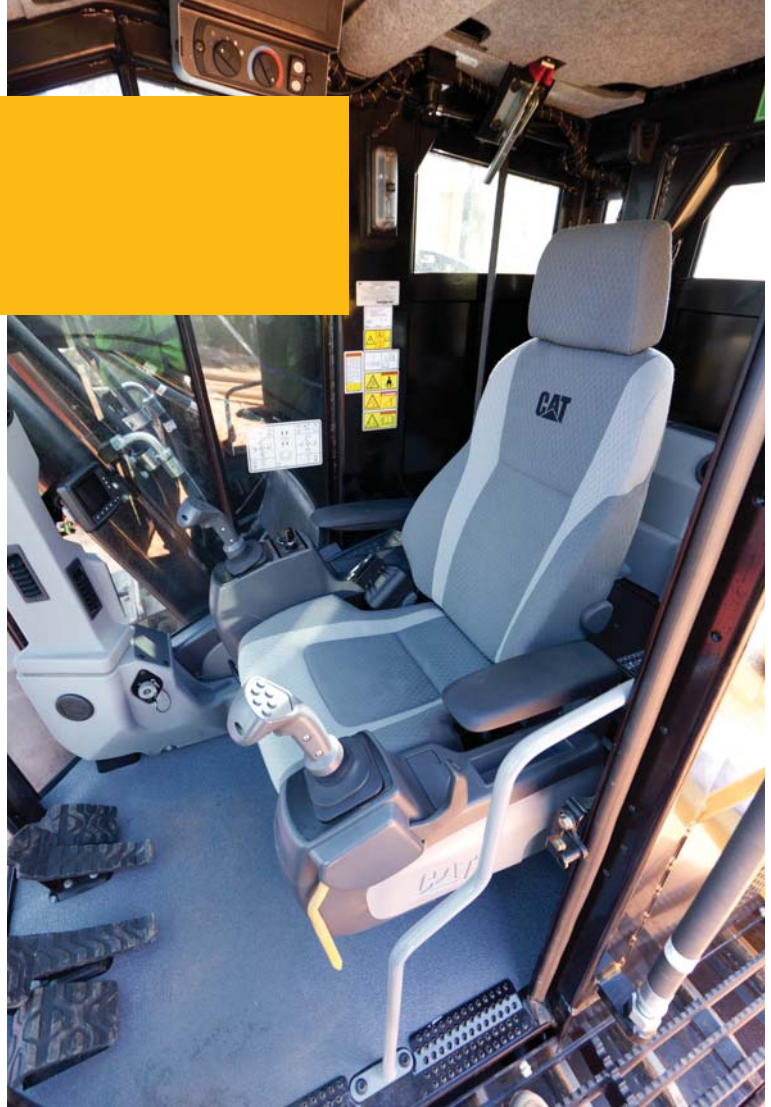



Leveling System

Stability and comfort in steep slope conditions.

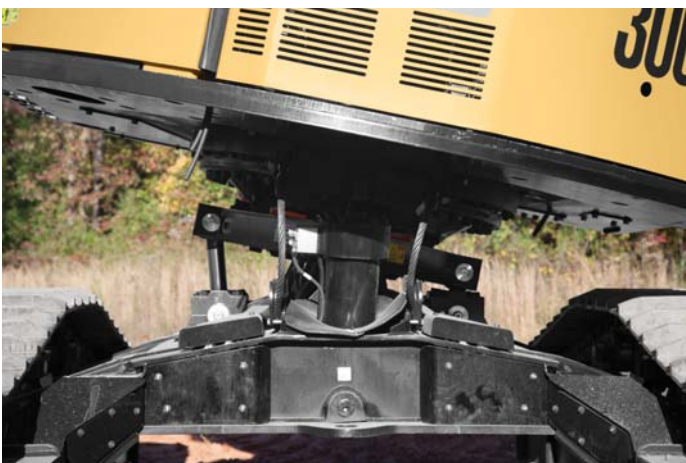

Tilt Mechanism

With the most robust tilt mechanism in the industry, the 522B tilter has a patented 3-cylinder tilt mechanism with simultaneous forward and side-by-side tilting. Trunnion cylinders are mounted on 51 mm (2 in) steel plates and transfer vertical loads down to the interface of the track frames and carbody, putting the load into the track and ground.

Cylinders

A three-cylinder tilt mechanism features simultaneously 21 degree forward tilt and 11 degree side-to-side tilt.



Ground Clearance

The 521B/522B machines have excellent ground clearance of 889 mm (35 in) and open carbody design. This provides increased mobility by eliminating carbody interference with large stumps, rocks or other obstacles.

Undercarriage

Heavy duty forestry undercarriage.

Undercarriage

The 521B and 522B Series machines utilize larger D7 size components providing extended life and reduced O&O costs.

Travel Motor

The proven final drives and travel motors provide up to 34 246 kg (75,500 lb) of tractive effort as standard on the 522B, giving excellent traction and power to the ground. An optional High Drawbar final drive is available on the 522B model providing increased tractive effort of 38 555 kg (85,000 lb). Three (3) travel speed range selections are standard.

Track Guards

All models feature full length track guards to maximize shoe support in all types of terrain.

Carbody

The 522B model features a bolted track frame to carbody design. This provides a narrower gauge width, or allows adjustment to a wider gauge width to improve machine stability, and increase productivity on steep slope applications. The 521B model features a welded track frame to carbody design with a fixed gauge, simplifying and reducing carbody weight. Both 521B and 522B provide maximum ground clearance and a smooth carbody under-surface to resist snagging on debris or large obstacles. The precision welded track frames reduce flexing and increase the durability of rollers and track links throughout the life of the machine.

Carrier Rollers

Both B Series models offer a choice of either standard single flange carrier rollers for moderate terrain and warm climates or star carrier rollers for severe terrain and cold climate applications. Nine bottom track rollers are used per side.



Boom and Stick

Maximum reach and lift capacity.

Boom and Stick

With up to 6124 kg (13,500 lb) of bare pin lift capacity at 6.2 m (20 ft 6 in), the 500 Series machines are dominant over competitors in their size classes. With market leading lift capacity, 8.1 m (26.6 ft) of maximum reach to cut, and tight stick tuck-in capabilities, these machines deliver high performance felling in all applications. The track harvester configuration delivers the same high performance with 4000 kg (8,800 lb) of bare pin lift capacity and 9.9 m (32 ft 6 in) of maximum reach.



Attachments

Work tool attachments to meet your needs.



Attachments

From plantation thinning to select cut of large diameter wood, Cat felling attachments provide reliable productive felling solutions. Designed to allow maximum visibility of the cutting area, all saws utilize high pressure hydraulics for fast saw recovery and quick arm speed. This provides a positive impact on production and better tree control.

Tilt

All models are available with a Cat 40 degree partial lateral tilt, or new 330 degree full lateral tilt.

Optimal HF Felling Head for ZTS B Series

Model	Cut Capacity	Weight-Partial Tilt	Weight-Full Tilt
HF201B	572 mm (22.5")	3200 kg (7,054 lb)	3669 kg (8,090 lb)



Sustainability

Maximum efficiency and productivity while conserving natural resources.

The B Series track feller bunchers are designed to maximize efficiency and productivity while conserving natural resources.

- The C9 ACERT engine meets all current U.S. EPA emission standards.
- The IQAN control system automatically adjusts the Flexxaire fan blade angle, reducing horsepower demand and lowering fuel consumption.
- Major structures and components are built to be rebuilt, reducing waste and replacement costs.

Serviceability

Easy servicing and extended service intervals.

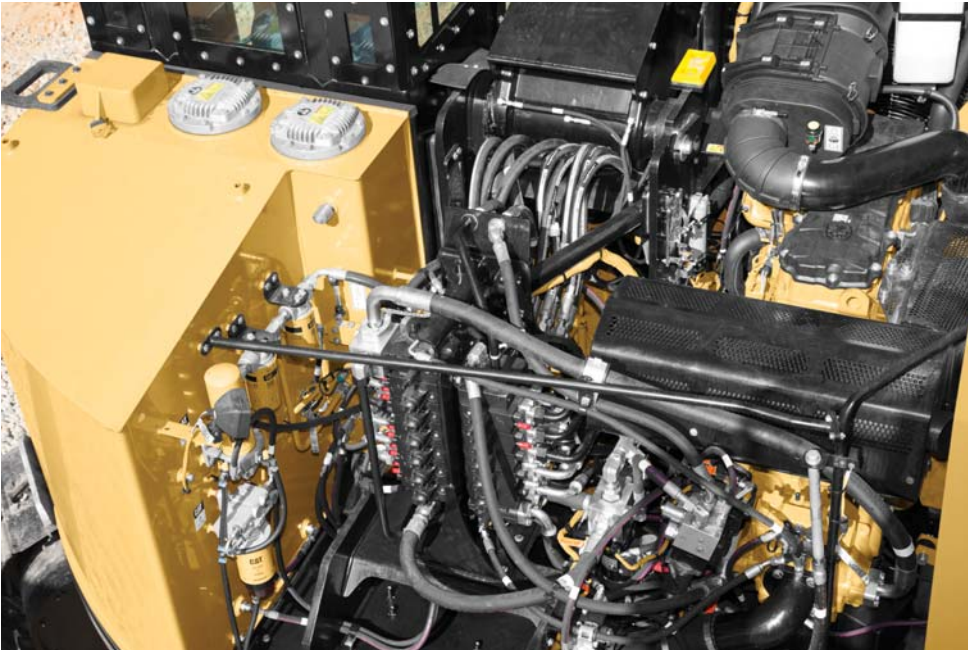

Extended Service Intervals

Caterpillar service and maintenance intervals have been extended to reduce machine service time, increase machine availability and reduce operating costs. Hydraulic oil change intervals can be extended from 2,000 hours to 4,000 hours. Engine coolant change intervals are 12,000 hour with Cat Extended Life Coolant/Anti-freeze. Regularly scheduled maintenance extends machine service life and lowers overall operating costs. 500-hour oil change interval reduces overall maintenance costs.



Flexxaire Fan

Standard Flexxaire fan automatically adjusts the fan blade pitch to optimize cooling and reduce fuel consumption. The reversing purge debris cycle frequency and duration can be set by operator in the cab to suit varying application conditions.

Clam-Shell Service Door

The hydraulically actuated clam-shell service door provides easy and quick access, reducing maintenance downtime.



Customer Support Count on your Cat dealer.

Caterpillar is known the world over for the quality of customer support from its dealer network – the industry’s best. No matter where you are, the expertise of a Cat dealer is always nearby. Your local Cat dealer is your forestry consultant who can recommend the machines, work tools and services to maximize your operation and provide the support to keep you at top productivity.

- 24-hour parts availability, where and when you need them, to minimize expensive downtime.
- Remanufactured parts that carry the same warranty as new parts at a reduced cost.
- Operator training to get the most out of your Cat equipment.
- Field services to provide on-site help when needed.
- Timely repair and replacement services.
- Customer Support Agreements to lower your operating costs.
- State-of-the-art diagnostic programs, such as S-O-SSM oil analysis, inspection services and trend reporting to help avoid unscheduled repairs.
- Financing programs for buying, renting or leasing Cat equipment.
- Cat Access Account, a fast and convenient way to pay for or rent anything offered at any Cat dealer or The Cat Rental Store.
- Cat Insurance to cover equipment losses from theft, collision, flood, upset or overturn, fire, vandalism and more.
- Product LinkTM to manage your equipment fleet through remote monitoring.
- Cat Certified Rebuild to get a second life from your equipment.

For more information on Cat products, dealer services and industry solutions, visit www.cat.com.

Power Train

Engine Model	Cat C9 ACERT	
Gross Power @ 1,800 rpm	226 kW	303 hp
Rated Power @ 2,100 rpm	210.3 kW	282 hp
Displacement	8.8 L	537 in ³

Operating Weights (without heads, standard counterweight)

Track Feller Buncher		
521B	27 501 kg	60,629 lb
522B	32 528 kg	71,711 lb
Track Harvester Configuration		
521B	26 966 kg	59,450 lb
522B	31 993 kg	70,532 lb

Boom System

Track Feller Buncher – Lift over front of tracks		
Maximum Reach (with head)	8.1 m	26 ft 6 in
Bare Pin Lift @ Maximum Reach (without head)	6100 kg @ 6.2 m	13,500 lb @ 20 ft 6 in
Track Harvester Configuration – Lift over front of tracks		
Maximum Reach (with head)	9.9 m	32 ft 6 in
Bare Pin Lift @ Maximum Reach (without head)	4000 kg @ 9.8 m	8,800 lb @ 32 ft 5 in

Service Refill Capacities

Fuel Capacity	856 L	226 gal
Cooling System	41 L	10.8 gal
Engine Oil	39 L	10.3 gal
Hydraulic System	448 L	118 gal
Swing Drive	10 L	2.6 gal

Hydraulic System

- Electric hydraulic oil fill pump
- Dedicated variable displacement pump for travel circuit – 200 cc
- Dedicated variable displacement pump for boom and implement functions – 200 cc
- Dedicated variable displacement pump for saw motor – 55 cc

Undercarriage

Size	330 EX (D7)	
Pitch	215.9 mm	8.5 in

Track Gauge

521B	2591 mm	102 in
522B	2591 mm- 2870 mm	102 in- 113 in

Track Length

4855 mm 191.1 in

Ground Clearance

889 mm 35 in

Tractive Effort

521B	31 978 kg	70,500 lb
522B	34 246 kg	75,500 lb
522B Optional High Drawbar	38 555 kg	85,000 lb

- Nine bottom rollers per side
- Integrated welded track guards – 521B
- Bolt-on track guards – 522B
- Leveling System
 - Non-leveling carbody – 521B
 - Three-cylinder tilt mechanism with simultaneous 21 degree forward tilt and 11 degree side-to-side tilt – 522B
- Standards
 - Cab meets FOPS/OPS/ROPS/WCB/OR-OSHA requirements

521B/522B Specifications

ZTS Track Harvesters Shipping Dimensions

All dimensions are approximate.

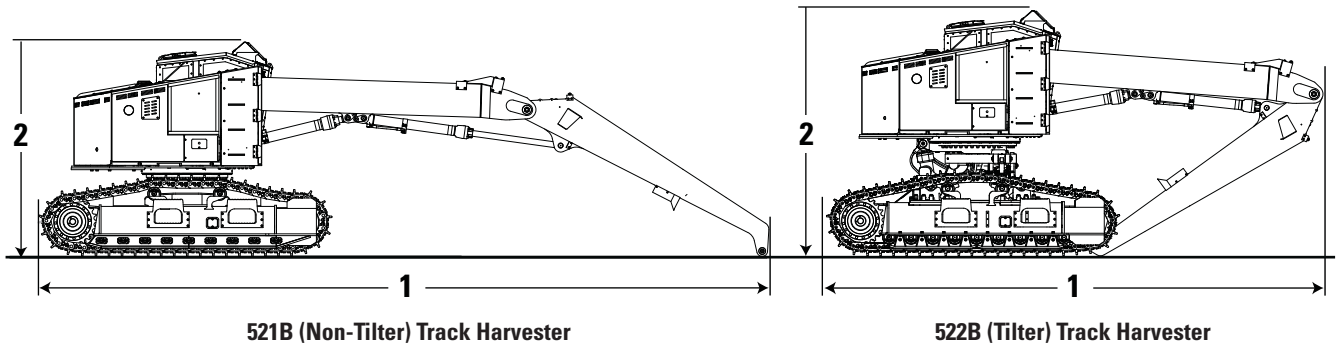

521B (Non-Tilter) Track Harvester

522B (Tilter) Track Harvester

MODEL	521B		522B (boom tucked)	
1 Length	12 151 mm	478 in	8222 mm	324 in
2 Height*	3761 mm	148 in	4011 mm	158 in
3 Width+	3200 mm	126 in	3200 mm	126 in
4 Width++		X	3480 mm	137 in
Weight	26 966 kg	59,450 lb	31 993 kg	70,532 lb

Length, Height and Width+ assume 610 mm (24 in) SG shoes

- * Height to the highest point on machine.
- + Minimum width with 610 mm (24 in) SG shoes.
- ++ Maximum width when undercarriage is set wide with 610 mm (24 in) SG shoes.

522B TFB models are shipped in the maximum width configuration using Width++ dimension. These illustrations and values are ESTIMATED only. These are subject to change based on attachments, configurations, add-ons, etc.

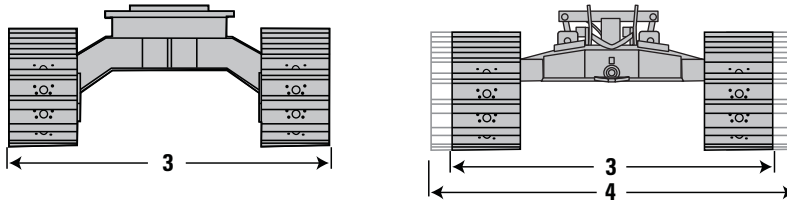

ZTS Track Feller Bunchers Shipping Dimensions

All dimensions are approximate.

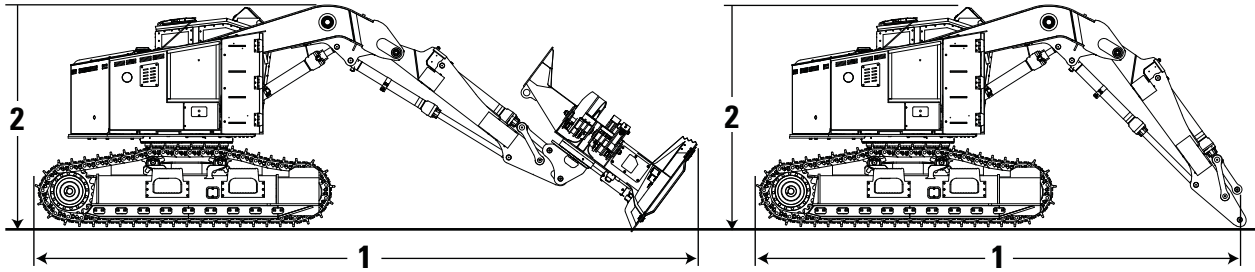

521B/522B Track Feller Bunchers

MODEL	521B		521B*		522B		522B*	
1 Length	8352 mm	329 in	10 708 mm	422 in	7700 mm	303 in	10 543 mm	415 in
2 Height**	3550 mm	140 in	3587 mm	141 in	3901 mm	154 in	3901 mm	154 in
3 Width+	3200 mm	126 in	3200 mm	126 in	3200 mm	126 in	3200 mm	126 in
4 Width++	X		X		3480 mm	137 in	3480 mm	137 in
Weight	27 501 kg	60,629 lb	30 707 kg	67,698 lb	32 528 kg	71,711 lb	35 734 kg	78,780 lb

Length, Height and Width assume 610 mm (24 in) SG shoes

* With HF 201 Partial Tilt Felling Head, tilted back and lifted (assumes an estimated additional head weight of 3213 kg (7,069 lb)).

** Height to the highest point on machine.

+ Minimum width.

++ Maximum width when undercarriage is set wide.

522B TFB models are shipped in the maximum width configuration using Width++ dimension.

These illustrations and values are ESTIMATED.

These are subject to change based on attachments, configurations, add-ons, etc.

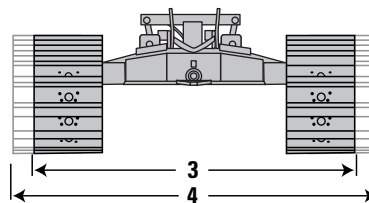
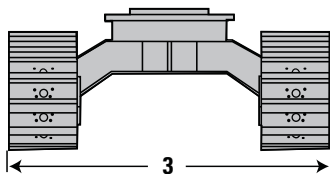

521B/522B Specifications

ZTS Track Feller Bunchers & Track Harvesters – Lift Range Diagrams

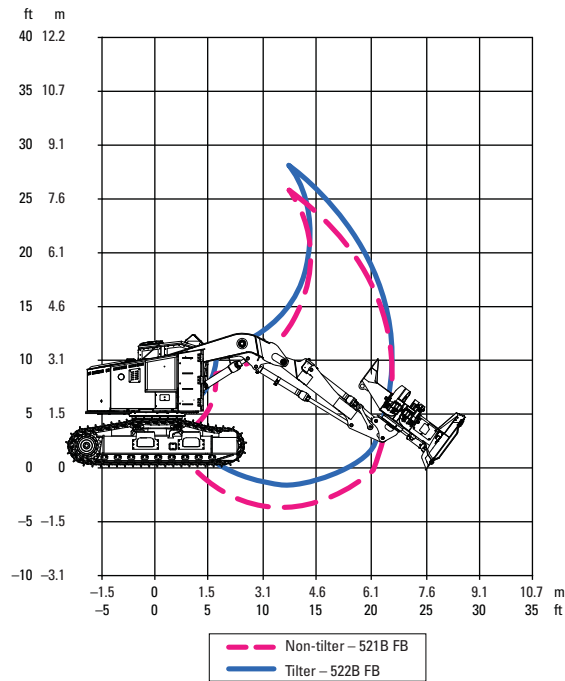

Felling Linkage 521B/522B – ZTS

Lift Over Front of Tracks

MODEL	521B		522B	
	Lift Capacity		Lift Capacity	
Reach				
2.4 m (8'0")	15 450 kg	34,000 lb	16 180 kg	35,600 lb
4.5 m (15'0")	8410 kg	18,500 lb	8545 kg	18,800 lb
6.2 m (20'6")	6100 kg	13,500 lb	6100 kg	13,500 lb

Lift Over Side of Tracks

MODEL	521B		522B	
	Lift Capacity		Lift Capacity	
Reach				
2.4 m (8'0")	15 450 kg	34,000 lb	16 180 kg	35,600 lb
4.5 m (15'0")	8410 kg	18,500 lb	8545 kg	18,800 lb
6.2 m (20'6")	6100 kg	13,500 lb	6100 kg	13,500 lb

Note: Lift capacity shown without attachment.
Additional reach and attachment weight will reduce lift capacity.

ZTS Track Feller Bunchers & Track Harvesters – Lift Range Diagrams

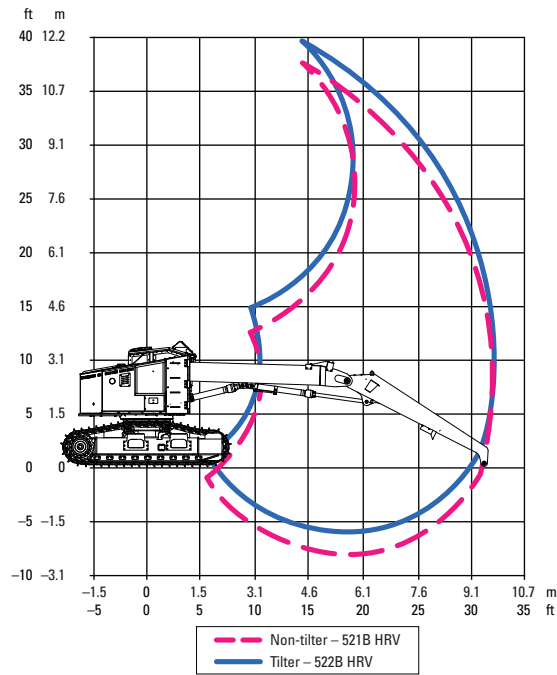

Harvesting Linkage 521B/522B – ZTS

Lift Over Front of Tracks

MODEL	521B		522B	
	Lift Capacity		Lift Capacity	
Reach				
3.6 m (12'0")	10 500 kg	23,000 lb	10 500 kg	23,000 lb
6.1 m (20'0")	7700 kg	17,000 lb	7700 kg	17,000 lb
9.8 m (32'5")	4000 kg	8,800 lb	4150 kg	9,100 lb

Lift Over Side of Tracks

MODEL	521B		522B	
	Lift Capacity		Lift Capacity	
Reach				
3.6 m (12'0")	10 500 kg	23,000 lb	10 500 kg	23,000 lb
6.1 m (20'0")	7700 kg	17,000 lb	7700 kg	17,000 lb
9.8 m (32'5")	3630 kg	8,000 lb	4150 kg	9,100 lb

Note: Lift capacity shown without attachment.
Additional reach and attachment weight will reduce lift capacity.

521B/522B Standard Equipment

Standard Equipment

Standard equipment may vary. Consult your Cat dealer for details.

ELECTRICAL

- 24 volt electrical system
- Two 12 volt maintenance free batteries with 950 CCA
- 95 Amp alternator
- IQAN programmable controls
- MD3 monitor display screen

GUARDS

- Hydraulically actuated hinged engine enclosure with warning alarm
- Engine fan guard
- Bottom guards
- Isolation mounted cab and engine
- Heavy duty radiator guard door

OPERATOR ENVIRONMENT

- OPS/FOPS/ROPS/WCB/OR-OSHA certified cab
- Dual joystick control
- Reverse slope windshield
- Air ride seat
- Skylight – alternate escape hatch
- Top escape hatch
- 76.2 mm (3 in) retractable seat belt
- DIN mount radio ready with speakers
- Operator sound suppression to standards
- Travel alarm
- Cup holders (2)
- Two 12 volt and one 24 volt power outlets
- Front window, 32 mm (1.25 in) thick Margard
- Positive filtered ventilation, pressurized cab with bi-level air conditioner, heater and defroster with manual control
- Left side fresh air window with screen
- Forced air fan
- Washable floor mat
- Neutral lever (lockout) for all controls

POWER TRAIN

- C9 ACERT engine meets U.S. EPA emission standards
- Variable travel speed (3 ranges)
- Under hood primary air filter
- 43° C (109° F) degree ambient temperature cooling package
 - Aluminum core ATAAC and side-by-side radiator and oil cooler
 - Removable debris screen
 - Swing out A/C condenser
- Electric fuel priming pump
- Fuel water separator

UNDERCARRIAGE

- Track roller guards with access holes
- Hydraulic track adjusters
- Double flange track rollers
- GFT80 Lohmann final drives (521B/522B)
- Cat 330 D7 size undercarriage components
- Nine (9) track rollers and two (2) carrier rollers per side
- Bolted, variable gauge leveling carbody with three cylinder tilt mechanism (522B)
- Welded, non-leveling carbody (521B)

HYDRAULICS

- Dedicated fixed displacement pilot pump
- Dedicated variable displacement pumps for track and implement functions
- Variable displacement saw pump for feller buncher hydraulics only
- 325 EX swing drive and swing motor
- Electric hydraulic oil fill pump
- High flow hydraulic arrangement for felling heads with two cylinder arm design 180 L/min (48 gal/min)
- Low flow hydraulic arrangement for felling heads with single cylinder and link design 120 L/min (32 gal/min)
- 265 L (70 gal) hydraulic tank

ANTIFREEZE

- 50% concentration extended life coolant

OTHER STANDARD EQUIPMENT

- Heavy duty hood enclosure
- Flexxaire fan
- Vandalism protection
- Spare hose storage area
- Grease gun bracket and storage area
- 856 L (226 gal) fuel tank

Optional Equipment

Optional equipment may vary. Consult your Cat dealer for details.

LINKAGES

- Harvester Long
- Intermittent
- Feller Buncher
- Omission – Linkage

HYDRAULICS

- Harvester
- Intermittent
- Feller Buncher – Low Flow
- Feller Buncher – High Flow

FELLING HEADS

- HF201B*
- HF221*

TRACK SYSTEMS

- 610 mm (24 in) SG pads, clipped corners, with mud/snow reliefs
- 711 mm (28 in) SG pads, clipped corners, with mud/snow reliefs
- 711 mm (28 in) DG pads, clipped corners, with mud/snow reliefs (521B)
- 914 mm (36 in) Tri-track, clipped corners, with mud/snow reliefs (521B)
- Star Carrier Rollers
- Standard Carrier Rollers

OTHER EQUIPMENT

- Lighting Gp-HID, replaces certain standard lights
- High Drawbar final drives (522B only)
- Heavy Counterweight
- Starting Aid, Cold Weather – includes two additional batteries
- Starting Aid, Arctic – includes engine and hydraulic oil Arctic heater

FIELD INSTALLED ATTACHMENTS

- Skylight, peaked, removable

*Heads available with Full Tilt 330 degree, or Partial Tilt 40 degree

For more complete information on Cat products, dealer services, and industry solutions, visit us on the web at www.cat.com

AEHQ7093 (07-2013)

© 2013 Caterpillar Inc.
All rights reserved

Materials and specifications are subject to change without notice. Featured machines in photos may include additional equipment. See your Cat dealer for available options.

CAT, CATERPILLAR, SAFETY.CAT.COM, their respective logos, "Caterpillar Yellow" and the "Power Edge" trade dress, as well as corporate and product identity used herein, are trademarks of Caterpillar and may not be used without permission.

