

980M/982M

Wheel Loaders

2017



	980M	982M
Engine Model	Cat® C13 ACERT™	Cat C13 ACERT
Maximum Power – ISO 14396	313 kW (426 hp metric)	321 kW (436 hp metric)
Maximum Net Power – ISO 9249	288 kW (392 hp metric)	297 kW (404 hp metric)
Bucket Capacities	4.2-12.0 m ³	4.6-12.0 m ³
Operating Weight	30 090 kg	35 563 kg

RELIABLE, PRODUCTIVE AND FUEL EFFICIENT

- Up to 10% more fuel efficient than the industry leading K Series*
- Up to 25% more fuel efficient than H Series*
- **Performance Series buckets** are easy to load and improve material retention
- **Work tools and coupler ready system** provide a wide range of work tools and allow the same work tool on different sizes of wheel loaders
- **Cat engine with ACERT Technology** meets EU Stage IV emission standards and includes Cat Clean Emissions Module for continuous and efficient operation
- **Advanced powershift transmission** with a standard lock up clutch torque converter and lock-to-lock shifting delivers smooth shifts, fast acceleration and speed on grade
- **Next generation axles** with optional limited slip differentials provide optimal traction in varying underfoot conditions for improved productivity
- **Next generation load-sensing hydraulic system** provides optimal control of machine functions

EASE OF OPERATION

- **Best-in-class operator environment** for unmatched operator comfort and efficiency
- **Advanced technology with Cat Connect** monitors, manages and enhances job site operations

SERVICE ACCESS

- Legacy one-piece hood, centralized service centers, windshield cleaning platform and harness tie-off provide the best in class service access

Contents

Reliable4

Durable5

Productive6

Fuel Efficient7

Easy to Operate8

Versatile10

Integrated Technologies12

Owning Costs14

Operating Costs15

Serviceable16

Sustainable17

Customer Support17

Specifications18

Standard Equipment32

Optional Equipment33

Notes34



**Fuel efficiency is measured in mass of material moved per volume of fuel burned. Average efficiency improvement as tested and analyzed for an average composite cycle and standard configuration with variations per comparable model with and without Economy Mode active. Factors influence result variation such as, but not limited to, machine configuration, operator technique, machine application, climate, etc.*



The new 980M and 982M Wheel Loaders have a Stage IV ACERT engine equipped with a combination of proven electronic, fuel, air and aftertreatment components. Applying proven technologies systematically and strategically lets us meet your high expectations for productivity and fuel efficiency. Deep system integration results in reduced emissions, improved performance and improved fuel economy without interrupting machine performance making it seamless to you. The reliability, durability, and versatility of both the 980M and 982M result in machines that are better built to meet your needs.

Thanks to its longer lift arm and higher hinge pin height compared to 980M, the new 982M excels in loading 30 to 34 tons on-highway trucks in quarry yards, small 36 tons rigid trucks or mobile breakers in quarry pits and large articulated trucks on construction sites. With larger buckets and other available work tools, the 982M will also boost production and fuel efficiency in coal handling and industrial applications, providing you with an exciting new option in this size class.

Reliable

Proven Components and Technology You Can Count On.



Every Stage IV ACERT engine is equipped with a combination of proven electronic, fuel, air and aftertreatment components.

More Powerful, Reliable Engine Electronics

The electronics used in Cat Stage IV engines are more powerful and robust than ever. Increased features and connection commonality improve the customer experience and increase quality and reliability. Over-foam wiring harness adds to reliability even in the most demanding applications.

Hydraulics

The 980M and 982M hydraulic systems have significant design changes and customer value improvements. The main hydraulic valve is now a mono-block with an integrated ride control section. The mono-block design reduces weight, has forty percent fewer leak points and is common across all M Series models. The auxiliary third function can be easily added at the factory or in the field with the addition of a second remote valve.

Equipment Monitoring

Cat Connect technologies and Cat dealer services take the guesswork out of equipment management. Product Link™ and the online VisionLink® application enable you to monitor real-time machine data and manage machines health. Your Cat dealer offers expert advice and S-O-SSM Services to maintain equipment reliability and efficiency.

Cold Start Package

The new optional cold start package provides dependable starts in extreme cold weather and high altitudes.

Durable

Better Designed to Meet Your Needs.



Frames

The robotically welded two-piece structural frame design provides strong and rigid structures that absorb all the forces associated to penetration, loading and twisting.

The M Series articulating hitch system, joining the front and rear frames, provides increased bearing force capacity.

Axles

The M Series axles are designed to handle extreme applications resulting in reliable performance and durable life. The rear axle can oscillate to ± 13 degrees helping to ensure all four wheels stay on the ground providing stability even in the roughest terrain, for excellent stability and traction.

Productive

Work Smart and Move More.



The right technologies fine-tuned for the right applications result in:

- **Improved Fluid Efficiency** – Up to 5% improvement over Stage IIIB products (including Diesel Exhaust Fluid consumption).
- **High Performance** across a variety of applications.
- **Enhanced Reliability** through commonality and simplicity of design.
- **Maximized Uptime and Reduced Cost** with world-class support from the Cat dealer network.
- **Minimized Impact of Emission Systems** – Designed to be transparent to the operator without requiring interaction.
- **Durable Designs** with long life to overhaul.
- **Delivering Better Fuel Economy** with minimized maintenance costs while providing the same great power and response.

Hydraulics

The new ride control system now has two accumulators enabling it to be more effective over a greater payload range, increasing productivity and operator efficiency due to a better ride.

The next generation implement pump continuously and automatically balance hydraulic loads with the machine performance desired by the operator.

Transmission

The 980M and 982M power trains have been improved with the addition of a lock-up clutch torque converter standard. These new torque converters have been matched with the engine power and hydraulics to improve performance and fuel efficiency. These rugged planetary transmissions also have a new split-flow oil system which use new multi-viscosity oil to improve fuel economy.

Axles

In addition to aggregates, sand and gravel and batch plants, these models are commonly used in heavy construction applications where poor underfoot conditions make traction difficult slowing production and challenging job deadlines. The optional limited slip differentials will improve tractive ability in these applications thereby increasing productivity.

The axles have new external caliper disc parking brakes mounted to the input shaft of the front axles. Since they are external, they do not have the inefficiencies of enclosed wet parking brakes due to brake discs running in oil nor is there any oil to change reducing fuel and maintenance costs. External caliper parking brakes are easily accessible for inspection and service.

Fuel Efficient

Engineered to Lower Your Operating Costs.

Engine and Emissions

The Cat C13 ACERT engine is designed for maximum fuel efficiency and increased power density, while meeting Stage IV emission standards. This engine features innovative Cat electronics, a fuel injection process, air-management systems; an aftertreatment solution with Cat Selective Catalytic Reduction, and a fuel efficient regeneration system, if required.

Efficient Systems and Components

Innovative systems intelligently lower the average working engine speeds and reduce the overall system heat loads which result in significantly improved performance and fuel efficiency.

Advanced Systems with Innovative Integration

The deep system integration of the new engine and emissions system, power train, hydraulic system and cooling system result in up to 10% lower fuel consumption compared to the 980K.

Economy Mode

The productive economy mode automatically controls the engine torque and speed based on the machine's power train load and places engine speed and torque in the most efficient operating range. The result is improved fuel efficiency while delivering optimal performance.



Next Generation Fuel Systems

Cat injection timing precisely controls the fuel injection process through a series of carefully timed microbursts, providing more control of combustion for the cleanest, most efficient fuel burn. On 980M and 982M the MEUI™ fuel systems boost performance and reduce soot for the C13 ACERT engine.

Cat NO_x Reduction System

The Cat NO_x Reduction System (NRS) captures and cools a small quantity of exhaust gas, then routes it back into the combustion chamber where it drives down combustion temperatures and reduces NO_x emissions.

Aftertreatment Technologies

To meet the additional 80% reduction in NO_x emissions required by Stage IV emission standards, one new system, the Selective Catalytic Reduction (SCR), has been added to the already proven Cat Stage IIIB aftertreatment solution.

Easy to Operate

Safe. Comfortable. Efficient.



Ensuring operators are safe, confident in the control of their machines, have a clean, comfortable and quiet operating environment with controls that are intuitive and low effort all contribute to lower operator fatigue and better performance.

Cab Access

A switch has been added to the electronic service center which unlatches the door remotely (optional). The gas strut then swings the door open. The angle of the steps up to the cab has been increased to an optimal fifteen degrees enabling operators to walk up like stairs versus climbing more vertically like a ladder. Grab handles have been repositioned so a secure three points of contact can be maintained at all times.

Visibility

Once in the cab, the new door securely seals against the new roll formed ROPS posts and the lower glass panel has been extended several inches to improve visibility to the left side of the machine. New larger convex mirrors improve visibility to the rear and integrated spot mirrors provide visibility close to both sides of the machine.

Sound and Vibration

The Cat air suspended seat, the viscous cab mount combined with lower engine speeds and an improved ride control system decrease noise and vibration the operator is subjected to, allowing him to remain efficient and productive the whole day long.



Central Display

The central display panel has a large text box, five analog gauges, and LED warning indicators. The large text box provides in-language information about machine operation, feature activation and system troubleshooting and calibration. With the five large analog gauges the operator can easily identify if key systems are within normal operating range.



Touch Screen Display

A new multipurpose color touch screen display dramatically simplifies the operator interface; with machine controls, rear vision camera and new fully integrated Cat Production Measurement system. Intuitive navigation with in-language text enables operators to modify certain machine operating parameters and monitor machine conditions literally at the touch of their fingers.

Control Panel

Sealed against moisture and dirt, the centralized switch panel with LEDs provides reliability and ready access to frequently required functions, even while wearing gloves. The ISO symbols located on each membrane switch are molded all the way through to ensure the image will not wear off over time.

The M Series maintains the “help” feature which explains the function of each membrane switch.

Focusing on operator efficiency, the control panel has been streamlined to include easy to reach highly utilized machine controls. The touch screen display enables the relocation of some expanded functions while eliminating the need for a second switch panel for further simplicity and easy machine operation.



Electro-Hydraulic (EH) Joystick Steering with Force Feedback (Speed Sensitive)

Your operators will enjoy and quickly adapt to the industry leading seat mounted EH joystick steering system, which provides precision control and dramatically decreases operator arm fatigue. For operators who prefer a steering wheel, an electro-hydraulic steering wheel is available as an option.

Implement Controls (EH)

Seat mounted single axis implement control levers provide your operator with precise control of the work tool, all while moving with the seat for maximum comfort. In-cab programmable kick-outs and automatic cylinder snubbing are easy to set on-the-go for tilt, lower and lift, ideal for repeatable cycles.



Ride Control

The next generation ride control works as a shock absorber, improving ride quality and smoothness over rough terrain, increasing your operator confidence, comfort and efficiency, ensuring excellent material retention.

Versatile

Linkage and Guard Options to Meet Your Various Applications Needs.



Z-bar Linkage

The proven Z-bar linkage combines digging efficiency with excellent visibility to the tool resulting in excellent penetration into the pile, high breakout forces and superior production capabilities.

High Lift Linkage

The optional high lift linkage on 980M offers increased hinge pin height to load more easily in a variety of applications with any type of bucket or fork.

Aggregate Handler

Aggregate packages are specialized offerings for specific loose aggregate rehandling applications, such as truck loading, hopper charging, stockpiling, and load and carry. Rehandling loose aggregate is less stressful to the machine, therefore payloads can be increased above other applications by installing larger buckets, counterweights and a scale system such as the Cat Production Measurement system.

To do so, the Cat aggregate packages require some prerequisites in terms of correct application, machine configuration and conformance to Caterpillar payload policy. Misapplication of Aggregate Handlers may result in significant reliability and durability risk.*

**Please consult your Cat dealer to ensure proper machine configuration selection in conformance to Caterpillar payload policy.*

Versatile

Do More Jobs with One Machine. Work Tool Options to Meet Your Needs.



An extensive range of work tools and bucket styles are available to customize these machines for your operation. Work tools are available either with pin on or quick coupler interface.

Performance Series Buckets

- **Load Easy, Fuel Efficient, Carry More** – Performance Series Buckets utilize a system-based approach to balance bucket shape with the machine’s linkage, weight, lift and tilt capacities. Operators benefit from reduced dig times and better material retention; ultimately translating into significant productivity and fuel efficiency improvements.
- **Lower Operating Costs** – Performance Series Buckets feature a longer floor that easily digs through the pile and provides excellent visibility for the operators to see when the bucket is full. Less time digging in the pile results in lower fuel consumption and improved tire life. A unique spill guard protects the cab and linkage components from material overflow.
- **Higher Productivity** – Performance Series Buckets achieve higher fill factors – ranging from 100% to 115% depending on the machine application and material type. The buckets feature a curved side profile to maximize material retention. The optimized design results in unsurpassed production capabilities.
- **Styles and Applications** – Performance Series Buckets are available for General Purpose, Material Handling, Rock, Heavy Duty Rock and Coal style buckets.

Specialty Buckets

- **Heavy Duty Quarry Rock Buckets** are designed for bank or face loading material where high impact/high abrasion is encountered. Buckets include thicker base edge, liner package and addition wear plates.
- **Slag Buckets** are designed for use in steel mills and slag processing centers. They feature increased material thickness in critical structural components to provide maximum durability for hot or cold slag handling.
- **Waste Handling Buckets** are designed to move large volumes of low-density waste in transfer stations, landfills and recycling yards. Large capacities give maximum production when loading conveyors, trucks or hoppers.
- **Woodchip Buckets** are optimized for moving large volumes of wood chips in forestry and millyard settings. They feature a flat floor and straight edge designed to scoop the bucket full and help heap the load high.

Quick Couplers and Work Tool Attachments

A Wheel Loader equipped with a quick coupler is a much more versatile machine. Buckets and work tools can be changed without leaving the cab – allowing the machine to quickly move from task to task.

- **Pallet Forks** are available for material handling.
- **Millyard and Logging Forks** are available for forestry applications.
- **Specialty Work Tool Attachments** such as plows for snow removal are available. Contact your local Cat dealer for more details on tools available for your application.





Integrated Technologies

Monitor, Manage, and Enhance Job Site Operations.

Cat Connect makes smart use of technology and services to improve your job site efficiency. Using the data from technology-equipped machines, you'll get more information and insight into your equipment and operations than ever before.

Cat Connect services are also available from your dealership including:

**Equipment Management** – increase uptime and reduce operating costs.

**Productivity** – monitor production and manage job site efficiency.

**Safety** – enhance job site awareness to keep your people and equipment safe.

Consult your local dealer on the services available.

Featured Cat Connect technologies include:

**LINK Technologies**
LINK technologies wirelessly connect you to your equipment giving you access to essential information you need to know to run your business. Link data can give you valuable insight into how your machine or fleet is performing so you can make timely, fact-based decisions that can boost job site efficiency and productivity.

- Product Link/VisionLink**
- Product Link is deeply integrated into your machine to take the guesswork out of equipment management.
 - Easy access to timely information like machine location, hours, fuel usage, idle time and event codes via the online VisionLink user interface can help you effectively manage your fleet and lower operating cost.

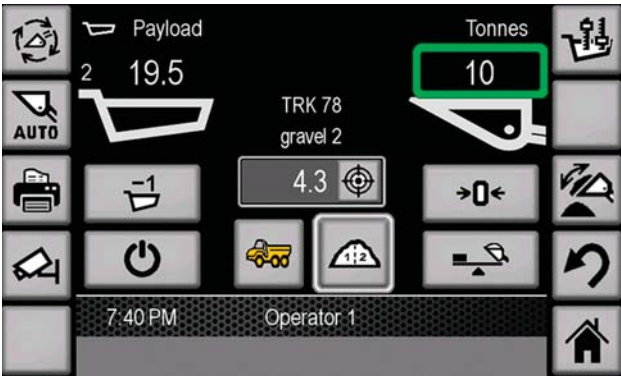

PAYLOAD Technologies

PAYLOAD technologies provide accurate weighing of materials being loaded and hauled. Payload data is displayed for loader operators in real-time to improve productivity, reduce overloading, and recorded to track material movement by shift.

Cat Production Measurement 2.0 (Optional)

- Brings payload weighing to the cab, enabling operators to weigh loads “on-the-go” during loading operations.
- Integrated Cat multi-function touchscreen display with graphical user interface is easy to understand and adds no clutter to the cab.
- Easy calibration procedure requires no special tools and reduces operational complexity.
- Low Lift Weigh and Tip-off features enable faster loading of trucks to their maximum capacity.
- VisionLink common back-office interface provides you a quick summary of loader operations, including payload productivity and efficiency.
- Optional Advanced Productivity subscription provides comprehensive actionable information to help you manage and improve the productivity and profitability of your operations.



DETECT Technologies

DETECT technologies enhance operator awareness of the environment around working equipment and provide alerts to help keep people and assets safe.

Rear Vision Camera

- Integrated into standard display, enhances visibility behind the machine helping you work confidently.
- Optional second display can be added to provide a dedicated rear view of the job site.

Rear Object Detection (Optional)

- Integrated into touchscreen display, the radar system warns an operator of an object in critical zone while going in reverse.
- Increased awareness of the working environment enhances site safety.

Owning Costs

Proven Best Investment.

Customer Support Agreements

A Customer Support Agreement (CSA) is an arrangement between you and your Cat dealer that helps you lower your total cost per ton. CSAs are flexible, allowing them to be tailored to your business needs. They can range from simple Preventive Maintenance Kits to elaborate Total Cost Performance Guarantees. Having a CSA with your Cat dealer enables more time for you to do what you do best – run your business.

Monitoring Systems

Monitoring product health is key to optimizing the life of an investment into a Cat Wheel Loader.

- **Cat Product Link** – Cat Product Link allows remote monitoring of equipment to improve overall fleet management effectiveness. Product Link is deeply integrated into machine systems. Events and diagnostic codes, as well as hours, fuel, idle time and other detailed information are transmitted to a secure web based application, VisionLink. VisionLink includes powerful tools to convey information to users and dealers, including mapping, working and idle time, fuel level and more.

- **S-O-S Services** – Helps manage component life and decrease machine downtime, increasing productivity and efficiency. Regular fluid sampling can help track what is going on inside your machine. Wear related problems are predictable and easily repairable. Maintenance can be done to accommodate your schedule, resulting in increased uptime and flexibility in maintenance repairs before failure.

Cat Autolube System

The optional, fully integrated Cat Autolube system provides full system monitoring and diagnostic test visibility by being integrated into the machine, display and VisionLink. Easy access to the refill pump and grease zerks means simple, fast servicing.

Parts Availability

Caterpillar provides an unsurpassed level of personalized service to help you work more cost effectively and efficiently. By utilizing a worldwide parts network Cat dealers help minimize machine downtime and save money by delivering replacement parts within 24 hours.

Resale Value

Owning quality equipment is an important factor in maintaining resale value. Caterpillar is not only known for machines that are better built, but provides product and dealer support to maintain the reliability and durability of your machine.



Operating Costs

Save Time and Money by Working Smart.



Machine configuration, operator technique, and job site layout can impact fuel consumption by as much as 30 percent. Data from customer machines show Cat wheel loaders are the most fuel efficient machines in the industry. Several features contribute to this excellent fuel efficiency:

- **New M Series Stage IV Engine, Hydraulics, Transmission and Ride Control** – Deep system integration results in reduced emissions, more productivity, lower fuel consumption, without interrupting machine performance – making it seamless to you and your operators. Machine requires Ultra Low Sulfur Diesel ULSD and DEF.
- **Optional Limited Slip Differentials** – Increase traction, reduce tire scuffing compared to other traction aids, further reducing your operating costs.
- **New External Caliper Disc Parking Brakes** – Easily accessible for maintenance.
- **Lock-up-Clutch Torque Converter and Shift Strategy** – Reduced torque interruption increases driveline efficiency, conserving fuel. Auto 1-4 transmission mode keeps engine rpm low, reducing fuel consumption while delivering optimal machine performance.
- **Machine Configuration** – Select the correct linkage, guarding, work tool and tire type based on machine application. Radial tires are preferred; ensure proper inflation pressures. Heavier tires burn more fuel.
- **Performance Series Buckets** – Deliver faster fill times and better material retention, ultimately reducing cycle times while improving productivity and fuel efficiency.

Enabling Application Efficiency

- **Loading Bucket** – Load in first gear and keep engine rpm low. Raise and tilt bucket smoother, with Caterpillar's multi-function capability, and do not use a "pumping" motion. Avoid lift lever detent and use of transmission neutralizer. Use programmable kick-outs and automatic cylinder snubbing during repeated cycles.
- **Loading Truck or Hopper** – Do not raise the work tool any higher than necessary. Keep engine rpm low and unload in controlled manner.
- **Idle** – Set the parking brake to engage Engine Idle Management System to conserve fuel.
- **Job Site Layout** – Spot loading targets in the right position. Avoid traveling more than twice the machine length during short cycle loading. Reduce transport distance for load and carry cycles by optimizing job site layout.

Serviceable

Easy to Maintain. Easy to Service.

Engine Access

The Cat sloped “one-piece” tilting hood provides industry leading access to the engine. Its design has further been improved on all M Series wheel loaders to provide the best-in-class service access to engine, oil levels and coolant sight gauge.

Cooling System

The cooling system ① is readily accessible for clean out and maintenance. With nine cooling fins per 25.4 mm and a perforated grill, most airborne debris entering the system passes through the cooler cores. The hydraulic and A/C cooler cores swing out providing easy access to both sides for cleaning. An access panel on the left side of the cooling package swings down to provide access to the back side of the engine coolant and Air-to-Air After Cooler (ATAAC). An optional variable pitch fan can automatically purge the cooler cores by periodically reversing the airflow when needed.

Service Centers

The hydraulic ② and electrical ③ service centers provide grouped access to numerous features, enhancing safety and convenience for your operators and service technicians, while reducing service time.

The electrical service center, located beneath the left platform, contains the maintenance free batteries, a fuse relay panel, main disconnect switch, engine shutdown switch, hood tilt switch, and the jump start receptacle.

The hydraulic service centers are now virtually identical for the M Series product line. This new consistent layout makes it easier for service technicians who work on a variety of M Series models.

Hydraulic system components on the 980M and 982M are protected by full flow and kidney-loop filtration. A filter in the hydraulic tank return line filters all of the oil returning to the tank. There is also a case drain screen for additional protection and finally, a separate kidney-loop filter with a finer micron rating continuously filters smaller particles out of the system. This multilevel design ensures the hydraulic oil is clean and thoroughly protects the rest of the hydraulic system from contamination. A new thermal bypass valve has been added to improve hydraulic system warm-up.



Sustainable Conserving Resources.

The 980M and 982M are designed to compliment your business plan, reduce emissions and minimize the consumption of natural resources.

- Improved fuel efficiency – less fuel consumed results in lower emissions.
- Improved operator efficiency through enhanced visibility and reduced noise levels.
- Link technologies enable you to collect and analyze equipment and job site data so you can maximize productivity and reduce costs.
- Major components are rebuildable, eliminating waste and saving money by giving the machine and/or major components a second life – and even a third life.

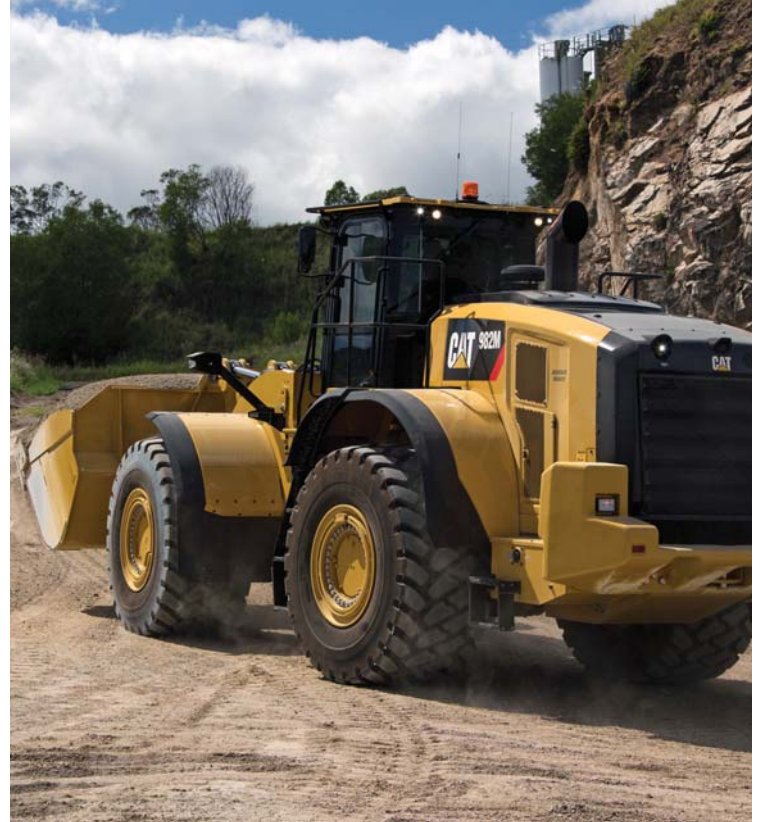

Customer Support Unmatched Support Makes the Difference.



Renowned Cat Dealer Support

- Your Cat dealer is ready to help you every step of the way. From new or used machine sales, to rental or rebuild options, your Cat dealer can provide an optimal solution to your business needs.
- Unsurpassed worldwide parts availability, trained technicians and customer support agreements maximize your machine uptime.
- Financing options are offered to meet a variety of customer needs.

980M/982M Wheel Loaders Specifications

Engine – 980M

Engine Model	Cat C13 ACERT
Maximum Power (1,700 rpm)	
ISO 14396	313 kW (426 hp metric)
Maximum Net Power (1,700 rpm)	
ISO 9249	288 kW (392 hp metric)
Peak Torque (1,200 rpm)	
ISO 14396	2182 N·m
Maximum Net Torque (1,100 rpm)	
ISO 9249	2054 N·m
Bore	130 mm
Stroke	157 mm
Displacement	12.5 L

- Cat engine with ACERT Technology – meets Stage IV emission standards.
- The power ratings apply at the stated speed when tested under the reference conditions for the specified standards.
- The net power advertised is the power available at the flywheel when the engine is equipped with fan, alternator, air cleaner and aftertreatment.
- The gross power advertised is with the fan at maximum speed.

Buckets – 980M

Bucket Capacities	4.2-12.0 m ³
-------------------	-------------------------

Weight – 980M

Operating Weight	30 090 kg
------------------	-----------

- Weight based on a machine configuration with Michelin 29.5R25 XLDD1 L4 radial tires, full fluids, operator, standard counterweight, cold start, roading fenders, Product Link, open differential axles (front/rear), secondary steering, sound suppression, and a 5.4 m³ general purpose bucket with BOCE.

Service Refill Capacities – 980M

Fuel Tank	426 L
DEF Tank	21 L
Cooling System	53 L
Crankcase	37 L
Transmission	77 L
Differentials and Final Drives – Front	84 L
Differentials and Final Drives – Rear	84 L
Hydraulic Tank	153 L

Engine – 982M

Engine Model	Cat C13 ACERT
Maximum Power (1,700 rpm)	
ISO 14396	321 kW (436 hp metric)
Maximum Net Power (1,700 rpm)	
ISO 9249	297 kW (404 hp metric)
Peak Torque (1,200 rpm)	
ISO 14396	2182 N·m
Maximum Net Torque (1,100 rpm)	
ISO 9249	2054 N·m
Bore	130 mm
Stroke	157 mm
Displacement	12.5 L

- Cat engine with ACERT Technology – meets Stage IV emission standards.
- The power ratings apply at the stated speed when tested under the reference conditions for the specified standards.
- The net power advertised is the power available at the flywheel when the engine is equipped with fan, alternator, air cleaner and aftertreatment.
- The gross power advertised is with the fan at maximum speed.

Buckets – 982M

Bucket Capacities	4.6-12.0 m ³
-------------------	-------------------------

Weight – 982M

Operating Weight	35 563 kg
------------------	-----------

- Weight based on a machine configuration with Bridgestone 875/65R29 VLTS L4 radial tires, full fluids, operator, standard counterweight, cold start, roading fenders, Product Link, open differential axles (front/rear), secondary steering, sound suppression, and a 6.1 m³ general purpose bucket with BOCE.

Service Refill Capacities – 982M

Fuel Tank	426 L
DEF Tank	21 L
Cooling System	53 L
Crankcase	37 L
Transmission	77 L
Differentials and Final Drives – Front	92 L
Differentials and Final Drives – Rear	92 L
Hydraulic Tank	153 L

980M/982M Wheel Loaders Specifications

Operating Specifications – 980M

Static Tipping Load – Full 40° Turn	
With Tire Deflection	19 565 kg
No Tire Deflection	20 796 kg
Breakout Force	224 kN

- For a machine configuration as defined under “Weight.”
- Full compliance to ISO 143971:2007 Sections 1 thru 6, which requires 2% verification between calculations and testing.

Transmission – 980M

Forward 1	6.9 km/h
Forward 2	13.3 km/h
Forward 3	23.5 km/h
Forward 4	39.5 km/h
Reverse 1	7.8 km/h
Reverse 2	15.2 km/h
Reverse 3	26.9 km/h
Reverse 4	39.5 km/h

- Maximum travel speed in standard vehicle with empty bucket and standard L4 tires with 933 mm roll radius.

Axles – 980M

Front	Fixed
Rear Oscillating	±13 degrees
Maximum Single-Wheel Rise and Fall	549 mm

Sound – 980M

The sound values indicated below are for specific operating conditions only. Machine and operator sound levels will vary at different engine and/or cooling fan speeds. Hearing protection may be needed when the machine is operated with a cabin that is not properly maintained, or when the doors and/or windows are open for extended periods or in a noisy environment.

Operator Sound Pressure Level (ISO 6396:2008)	72 dB(A)
Exterior Sound Power Level (ISO 6395:2008)	109 dB(A)*
European Union Directive “2000/14/EC” as amended by “2005/88/EC”	
Exterior Sound Pressure Level (SAE J88:2013)	78 dB(A)**

*For a standard machine configuration, measured according to the procedures specified with the cooling fan speed set at 70% of maximum value.

**For a standard machine configuration, measured according to the procedures specified. The measurement was conducted under the following conditions: distance of 15 m (49.2 ft), moving forward in second gear ratio with the cooling fan speed set at maximum value.

Operating Specifications – 982M

Static Tipping Load – Full 40° Turn	
With Tire Deflection	21 080 kg
No Tire Deflection	22 393 kg
Breakout Force	260 kN

- For a machine configuration as defined under “Weight.”
- Full compliance to ISO 143971:2007 Sections 1 thru 6, which requires 2% verification between calculations and testing.

Transmission – 982M

Forward 1	6.2 km/h
Forward 2	11.9 km/h
Forward 3	21.1 km/h
Forward 4	37.5 km/h
Reverse 1	7.0 km/h
Reverse 2	13.6 km/h
Reverse 3	24.1 km/h
Reverse 4	39.5 km/h

- Maximum travel speed in standard vehicle with empty bucket and standard L4 tires with 914 mm roll radius.

Axles – 982M

Front	Fixed
Rear Oscillating	±13 degrees
Maximum Single-Wheel Rise and Fall	571 mm

Sound – 982M

The sound values indicated below are for specific operating conditions only. Machine and operator sound levels will vary at different engine and/or cooling fan speeds. Hearing protection may be needed when the machine is operated with a cabin that is not properly maintained, or when the doors and/or windows are open for extended periods or in a noisy environment.

Operator Sound Pressure Level (ISO 6396:2008)	72 dB(A)
Exterior Sound Power Level (ISO 6395:2008)	109 dB(A)*
European Union Directive “2000/14/EC” as amended by “2005/88/EC”	
Exterior Sound Pressure Level (SAE J88:2013)	78 dB(A)**

*For a standard machine configuration, measured according to the procedures specified with the cooling fan speed set at 70% of maximum value.

**For a standard machine configuration, measured according to the procedures specified. The measurement was conducted under the following conditions: distance of 15 m (49.2 ft), moving forward in second gear ratio with the cooling fan speed set at maximum value.

980M/982M Wheel Loaders Specifications

Hydraulic System

Implement Pump Type	Variable Displacement Piston
Implement System	
Maximum Pump Output (2,250 rpm)	449 L/min
Maximum Operating Pressure	34 300 kPa
Optional 3 rd Function Maximum Flow	240 L/min
Optional 3 rd Function Maximum Pressure	21 780 kPa
Hydraulic Cycle Time with Rated Payload:	
Raise from Carry Position	5.3 Seconds
Dump, at Maximum Raise	1.7 Seconds
Lower, Empty, Float Down	3.1 Seconds
Total	10.1 Seconds

Brakes

Brakes	Brakes meet ISO 3450:2011 standards
--------	---

Air Conditioning System

The air conditioning system on this machine contains the fluorinated greenhouse gas refrigerant R134a (Global Warming Potential = 1430). The system contains 1.6 kg of refrigerant with has a CO₂ equivalent 2.288 metric tonne.

Cab

ROPS/FOPS	ROPS/FOPS meet ISO 3471:2008 and ISO 3449:2005 Level II standards
-----------	--

980M/982M Wheel Loaders Specifications

980M Dimensions

All dimensions are approximate.

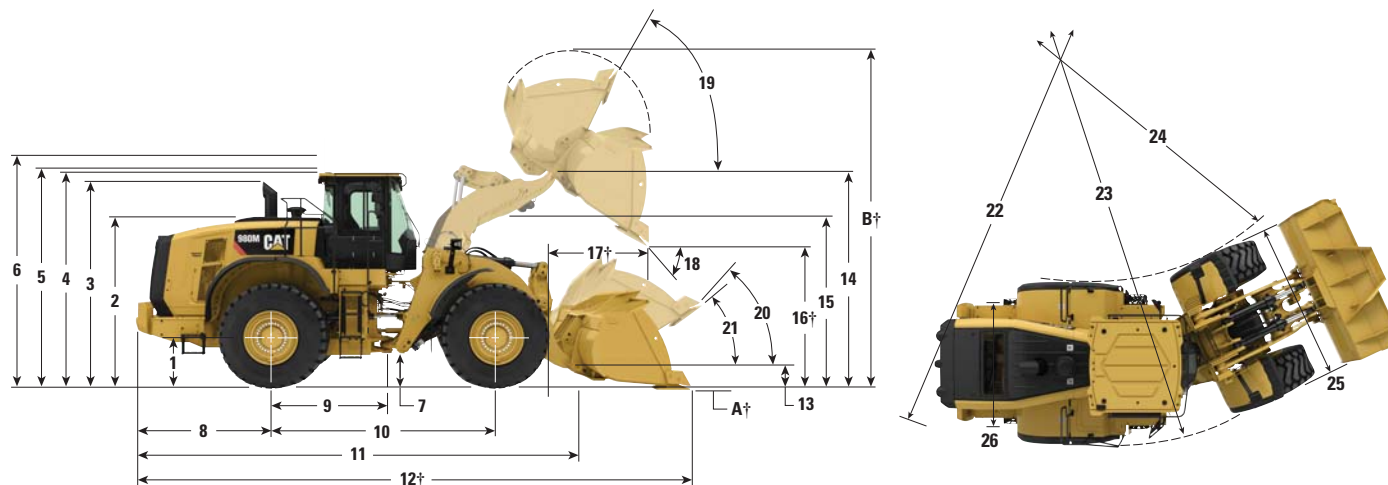

	Standard Lift	High Lift
1 Height to Axle Centerline	892 mm	892 mm
2 Height to Top of Hood	3110 mm	3110 mm
3 Height to Top of Exhaust Pipe	3746 mm	3746 mm
4 Height to Top of ROPS	3813 mm	3813 mm
5 Height to Top of Product Link Antenna	3891 mm	3891 mm
6 Height to Top of Warning Beacon	4112 mm	4112 mm
7 Ground Clearance	453 mm	453 mm
8 Center Line of Rear Axle to Edge of Counterweight	2469 mm	2469 mm
9 Center Line of Rear Axle to Hitch	1900 mm	1900 mm
10 Wheelbase	3800 mm	3800 mm
11 Overall Length (without bucket)	7964 mm	8164 mm
12 Shipping Length (with bucket level on ground)*†	9493 mm	9799 mm
13 Hinge Pin Height at Carry Height	621 mm	678 mm
14 Hinge Pin Height at Maximum Lift	4539 mm	4760 mm
15 Lift Arm Clearance at Maximum Lift	3795 mm	4010 mm
16 Dump Clearance at Maximum Lift and 45° Discharge*†	3273 mm	3493 mm
17 Reach at Maximum Lift and 45° Discharge*†	1481 mm	1484 mm
18 Dump Angle at Maximum Lift and Dump (on stops)*	52 degrees	55 degrees
19 Rack Back at Maximum Lift*	61 degrees	61 degrees
20 Rack Back at Carry Height*	48 degrees	48 degrees
21 Rack Back at Ground*	40 degrees	39 degrees
22 Clearance Circle (dia) to Counterweight	13 700 mm	13 700 mm
23 Clearance Circle (dia) to Outside of Tires	14 806 mm	14 806 mm
24 Clearance Circle (dia) to Inside of Tires	8252 mm	8252 mm
25 Maximum Width over Tires (unloaded)	3265 mm	3265 mm
Maximum Width over Tires (loaded)	3296 mm	3296 mm
26 Tread Width	2440 mm	2440 mm

*With 5.4 m³ general purpose pin on bucket with BOCE (see Operating Specifications for other buckets)

†Dimensions are listed in Operating Specification charts.

All height and tire related dimensions are with Michelin 29.5R25 XLDD1 L4 radial tires and standard counterweight (see Dimension Changes – Tires chart for other tires).

“Width over Tires” dimensions are over the bulge and include growth.

980M/982M Wheel Loaders Specifications

982M Dimensions

All dimensions are approximate.

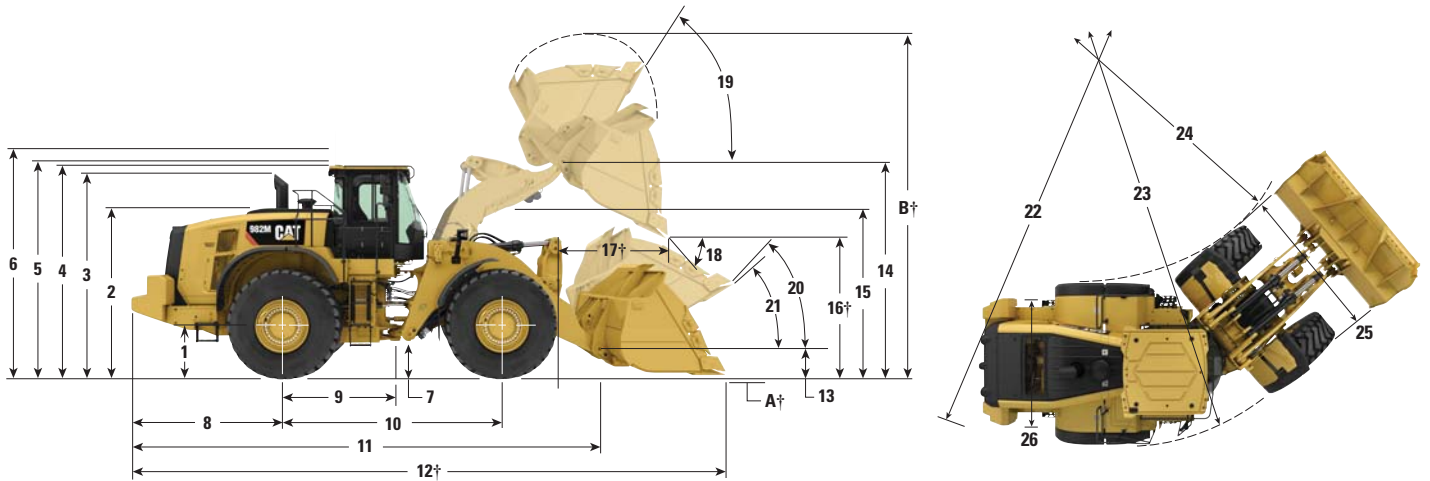

	Standard Lift
1 Height to Axle Centerline	874 mm
2 Height to Top of Hood	3083 mm
3 Height to Top of Exhaust Pipe	3719 mm
4 Height to Top of ROPS	3786 mm
5 Height to Top of Product Link Antenna	3864 mm
6 Height to Top of Warning Beacon	4085 mm
7 Ground Clearance	426 mm
8 Center Line of Rear Axle to Edge of Counterweight	2716 mm
9 Center Line of Rear Axle to Hitch	1900 mm
10 Wheelbase	3800 mm
11 Overall Length (without bucket)	8584 mm
12 Shipping Length (with bucket level on ground)*†	10 177 mm
13 Hinge Pin Height at Carry Height	790 mm
14 Hinge Pin Height at Maximum Lift	4743 mm
15 Lift Arm Clearance at Maximum Lift	3884 mm
16 Dump Clearance at Maximum Lift and 45° Discharge*†	3365 mm
17 Reach at Maximum Lift and 45° Discharge*†	1569 mm
18 Dump Angle at Maximum Lift and Dump (on stops)*	50 degrees
19 Rack Back at Maximum Lift*	57 degrees
20 Rack Back at Carry Height*	48 degrees
21 Rack Back at Ground*	42 degrees
22 Clearance Circle (dia) to Counterweight	13 950 mm
23 Clearance Circle (dia) to Outside of Tires	15 026 mm
24 Clearance Circle (dia) to Inside of Tires	8148 mm
25 Maximum Width over Tires (unloaded)	3452 mm
Maximum Width over Tires (loaded)	3499 mm
26 Tread Width	2540 mm

*With 6.1 m³ general purpose pin on bucket with BOCE (see Operating Specifications for other buckets)

†Dimensions are listed in Operating Specification charts.

All height and tire related dimensions are with Bridgestone 875/65R29 VLTS L4 radial tires and standard counterweight (see Dimension Changes – Tires chart for other tires). "Width over Tires" dimensions are over the bulge and include growth.

980M/982M Wheel Loaders Specifications

980M Dimension Changes – Tires

Tire Brand	Michelin	Michelin	Michelin	Bridgestone	Bridgestone	Bridgestone
Tire Size	29.5R25	29.5R25	29.5R25	29.5R25	29.5R25	29.5R25
Tread Type	L-3	L-5	L-5	L-3	L-4	L-5
Tread Pattern	XHA2	XLDD2	XMINE D2	VMT	VSNT	VSDL
Width over Tires – Maximum (empty)*	3273 mm	3269 mm	3281 mm	3257 mm	3243 mm	3252 mm
Width over Tires – Maximum (loaded)*	3293 mm	3297 mm	3295 mm	3284 mm	3265 mm	3274 mm
Change in Vertical Dimensions (average of front and rear)	-33 mm	-6 mm	9 mm	-21 mm	4 mm	23 mm
Change in Horizontal Reach	23 mm	3 mm	3 mm	21 mm	1 mm	-10 mm
Change in Clearance Circle to Outside of Tires	-4 mm	1 mm	-2 mm	-13 mm	-32 mm	-23 mm
Change in Clearance Circle to Inside of Tires	4 mm	-1 mm	2 mm	13 mm	32 mm	23 mm
Change in Operating Weight (without Ballast)	-544 kg	364 kg	688 kg	-356 kg	156 kg	864 kg
Change in Static Tipping Load – Straight	-411 kg	275 kg	519 kg	-269 kg	118 kg	652 kg
Change in Static Tipping Load – Articulated	-357 kg	239 kg	452 kg	-234 kg	102 kg	568 kg

*Width over bulge and includes tire growth.

NOTE: Changes compared to 980M with Michelin XLDD1 L4 tires.

982M Dimension Changes – Tires

Tire Brand	Michelin	Bridgestone	Bridgestone
Tire Size	875/65R29	875/65R29	29.5R29
Tread Type	L-3	L-3	L-5
Tread Pattern	XHA2	VTS	VSDL
Width over Tires – Maximum (empty)*	3473 mm	3447 mm	3425 mm
Width over Tires – Maximum (loaded)*	3504 mm	3472 mm	3448 mm
Change in Vertical Dimensions (average of front and rear)	-6 mm	-7 mm	82 mm
Change in Horizontal Reach	-1 mm	2 mm	-70 mm
Change in Clearance Circle to Outside of Tires	28 mm	-4 mm	-28 mm
Change in Clearance Circle to Inside of Tires	-28 mm	4 mm	28 mm
Change in Operating Weight (without Ballast)	-356 kg	-76 kg	1008 kg
Change in Static Tipping Load – Straight	-236 kg	-50 kg	667 kg
Change in Static Tipping Load – Articulated	-206 kg	-44 kg	583 kg

*Width over bulge and includes tire growth.

NOTE: Changes compared to 982M with Bridgestone 875/65R29 VLTS L4 tires.

980M/982M Wheel Loaders Specifications

980M Operating Specifications with Buckets

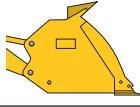
Linkage	Standard Linkage						High Lift Linkage Change**	
Pin/Quick Coupler								
Bucket Type	General Purpose				General Purpose Heavy Duty			
Edge Type	Bolt-On Cutting Edges	Teeth and Segments	Bolt-On Cutting Edges	Teeth and Segments	Bolt-On Cutting Edges	Teeth and Segments		
Capacity – Rated	m ³	5.40	5.40	5.70	5.70	5.70	5.70	—
Capacity – Rated at 110% Fill Factor	m ³	5.94	5.94	6.27	6.27	6.27	6.27	—
Width	mm	3447	3535	3447	3535	3447	3535	—
16 † Dump Clearance at Maximum Lift and 45° Discharge	mm	3273	3107	3204	3037	3204	3037	221
17 † Reach at Maximum Lift and 45° Discharge	mm	1481	1618	1529	1663	1529	1663	3
Reach at Level Lift Arm and Bucket Level	mm	2965	3177	3049	3261	3049	3261	160
A † Digging Depth	mm	103	103	103	103	103	103	-2
12 † Shipping Length (with Bucket)	mm	9493	9734	9577	9818	9577	9818	201
B † Overall Height with Bucket at Maximum Lift	mm	6421	6421	6243	6243	6243	6243	221
Loader Clearance Circle with Bucket at Carry Position	mm	15 223	15 451	15 270	15 498	15 270	15 498	1009
Static Tipping Load, Straight (With Tire Deflection)*	kg	22 639	22 453	22 391	22 204	22 232	22 045	-1939
Static Tipping Load, Straight (No Tire Deflection)*	kg	24 023	23 835	23 775	23 586	23 614	23 425	-2145
Static Tipping Load, Articulated (With Tire Deflection)*	kg	19 565	19 379	19 334	19 147	19 175	18 988	-1321
Static Tipping Load, Articulated (No Tire Deflection)*	kg	20 796	20 608	20 567	20 378	20 406	20 217	-1500
Breakout Force***	kN	224	222	211	209	211	209	17
Operating Weight*	kg	30 090	30 228	30 173	30 311	30 319	30 458	115

*Static tipping loads and operating weights shown are based on a machine configuration with Michelin 29.5R25 XLDD1 L4 radial tires, full fluids, operator, standard counterweight, cold start, roading fenders, Product Link, limited slip differentials, power train guard, secondary steering and sound suppression.

**Maximum values.

***Measured 102 mm behind tip of cutting edge with bucket hinge pin as pivot in accordance with SAE J732C.

Specifications and ratings conform to all applicable standards recommended by the Society of Automotive Engineers, including SAE Standard J732C governing loader ratings.

(With Tire Deflection) Full compliance to ISO 14397-1 (2007) Sections 1 thru 6, which requires 2% verification between calculations and testing.

(No Tire Deflection) Compliance to ISO 14397-1 (2007) Sections 1 thru 5.

†Illustration shown with Dimension charts.

Other buckets are available and offerings vary by region. Consult your local Cat dealer for further details.

980M/982M Wheel Loaders Specifications

980M Operating Specifications with Buckets

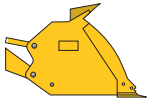
Linkage	Standard Linkage						High Lift Linkage Change**
Pin/Quick Coupler							
Bucket Type	Material Handling HD	Rock V-Edge	Rock V-Edge	HD Rock V-Edge	Coal		
Edge Type	FMT	Teeth and Segments	Teeth and Segments	Teeth and Segments	Bolt-On Cutting Edges		
Capacity – Rated	m ³	5.60	4.50	5.40	5.40	8.20	—
Capacity – Rated at 110% Fill Factor	m ³	6.15	4.93	5.91	5.95	9.02	—
Width	mm	3580	3504	3504	3645	3638	—
16 † Dump Clearance at Maximum Lift and 45° Discharge	mm	3201	3051	2890	2941	2917	221
17 † Reach at Maximum Lift and 45° Discharge	mm	1389	1713	1904	1890	1625	3
Reach at Level Lift Arm and Bucket Level	mm	2968	3284	3533	3486	3336	160
A † Digging Depth	mm	74	106	71	77	108	-2
12 † Shipping Length (with Bucket)	mm	9472	9827	10 076	10 035	9867	202
B † Overall Height with Bucket at Maximum Lift	mm	6486	6204	6378	6378	6536	221
Loader Clearance Circle with Bucket at Carry Position	mm	15 324	15 468	15 614	15 718	15 609	1009
Static Tipping Load, Straight (With Tire Deflection)*	kg	21 213	22 740	22 412	21 524	21 615	-1983
Static Tipping Load, Straight (No Tire Deflection)*	kg	22 555	24 137	23 824	22 925	23 054	-2191
Static Tipping Load, Articulated (With Tire Deflection)*	kg	18 184	19 589	19 299	18 395	18 575	-1350
Static Tipping Load, Articulated (No Tire Deflection)*	kg	19 377	20 830	20 557	19 642	19 864	-1531
Breakout Force***	kN	220	208	191	192	175	17
Operating Weight*	kg	31 109	30 978	31 024	31 742	30 677	115

*Static tipping loads and operating weights shown are based on a machine configuration with Michelin 29.5R25 XLDD1 L4 radial tires, full fluids, operator, standard counterweight, cold start, roading fenders, Product Link, limited slip differentials, power train guard, secondary steering and sound suppression.

**Maximum values.

***Measured 102 mm behind tip of cutting edge with bucket hinge pin as pivot in accordance with SAE J732C.

Specifications and ratings conform to all applicable standards recommended by the Society of Automotive Engineers, including SAE Standard J732C governing loader ratings.

(With Tire Deflection) Full compliance to ISO 14397-1 (2007) Sections 1 thru 6, which requires 2% verification between calculations and testing.

(No Tire Deflection) Compliance to ISO 14397-1 (2007) Sections 1 thru 5.

†Illustration shown with Dimension charts.

Other buckets are available and offerings vary by region. Consult your local Cat dealer for further details.

FMT = Flush Mounted Teeth

HD = Heavy Duty

980M/982M Wheel Loaders Specifications

980M Operating Specifications with Buckets – Aggregate Handler

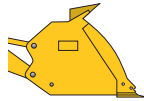
Linkage		Aggregate Handler		
Pin/Quick Coupler				
		Pin On		
Bucket Type		General Purpose		Coal
Edge Type		Bolt-On Cutting Edges	Bolt-On Cutting Edges	Bolt-On Cutting Edges
Capacity – Rated	m ³	5.70	6.00	8.20
Capacity – Rated at 110% Fill Factor	m ³	6.27	6.60	9.02
Width	mm	3447	3447	3638
16 † Dump Clearance at Maximum Lift and 45° Discharge	mm	3204	3187	2917
17 † Reach at Maximum Lift and 45° Discharge	mm	1529	1550	1625
Reach at Level Lift Arm and Bucket Level	mm	3049	3077	3336
A † Digging Depth	mm	103	103	108
12 † Shipping Length (with Bucket)	mm	9638	9666	9928
B † Overall Height with Bucket at Maximum Lift	mm	6243	6269	6536
Loader Clearance Circle with Bucket at Carry Position	mm	15 270	15 285	15 609
Static Tipping Load, Straight (With Tire Deflection)*	kg	23 972	23 827	23 180
Static Tipping Load, Straight (No Tire Deflection)*	kg	25 481	25 339	24 750
Static Tipping Load, Articulated (With Tire Deflection)*	kg	20 630	20 491	19 857
Static Tipping Load, Articulated (No Tire Deflection)*	kg	21 997	21 860	21 286
Breakout Force**	kN	211	207	175
Operating Weight*	kg	30 822	30 918	31 326

*Static tipping loads and operating weights shown are based on a machine configuration with Michelin 29.5R25 XLDD1 L4 radial tires, full fluids, operator, aggregate counterweight, cold start, roading fenders, Product Link, limited slip differentials, power train guard, secondary steering and sound suppression.

**Measured 102 mm behind tip of cutting edge with bucket hinge pin as pivot in accordance with SAE J732C.

Specifications and ratings conform to all applicable standards recommended by the Society of Automotive Engineers, including SAE Standard J732C governing loader ratings.

(With Tire Deflection) Full compliance to ISO 14397-1 (2007) Sections 1 thru 6, which requires 2% verification between calculations and testing.

(No Tire Deflection) Compliance to ISO 14397-1 (2007) Sections 1 thru 5.

†Illustration shown with Dimension charts.

Aggregate Handler configuration is not compatible with teeth and segments, tips, rock buckets, high lift, and L5 tires.

Other buckets are available and offerings vary by region. Consult your local Cat dealer for further details.

980M/982M Wheel Loaders Specifications

982M Bucket Fill Factors Chart

The bucket size must be chosen based on the density of the material and on the expected fill factor. The new Cat Performance Series Buckets with longer floor, larger bucket opening, increased repository angle, rounded side boards and integrated spill guard, demonstrate fill factors significantly higher than previous generation or non Cat buckets. The actual volume handled by the machine is thus often larger than the rated capacity.

Loose Material		Fill Factor (%)*	Material Density
Earth/Clay		115	1.5-1.7
Sand and Gravel		115	1.5-1.7
Aggregate:	25-76 mm	110	1.6-1.7
	19 mm and smaller	105	1.8
Rock:	76 mm and larger	100	1.6

*As a % of ISO rated capacity.

Note: Fill Factors achieved will also depend on whether the product is washed or not washed.

982M Bucket Selection Chart

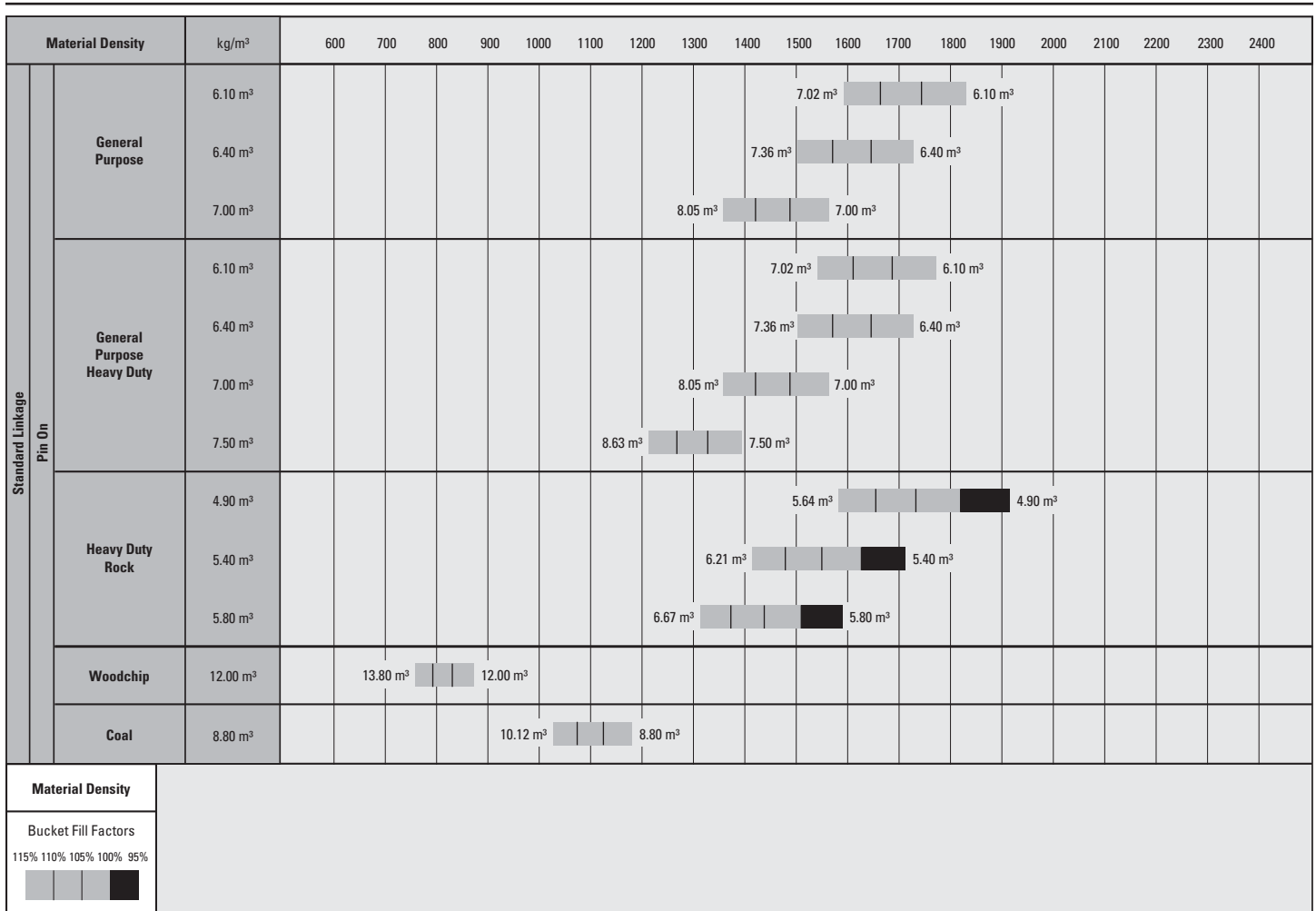

Note: All buckets are showing Bolt-On Edges.

980M/982M Wheel Loaders Specifications

982M Operating Specifications with Buckets

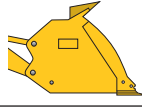
Linkage		Standard Linkage						
Pin/Quick Coupler								
		Pin On						
Bucket Type		General Purpose			Heavy Duty General Purpose			Heavy Duty Quarry Rock
Edge Type		Bolt-On Cutting Edges	Teeth and Segments	Bolt-On Cutting Edges	Bolt-On Cutting Edges	Teeth and Segments	Bolt-On Cutting Edges	Teeth and Segments
Capacity – Rated	m ³	6.10	6.10	6.40	6.10	6.10	6.40	5.40
Capacity – Rated at 110% Fill Factor	m ³	6.71	6.71	7.04	6.71	6.71	7.04	5.94
Width	mm	3602	3665	3602	3602	3665	3602	3648
16 † Dump Clearance at Maximum Lift and 45° Discharge	mm	3365	3197	3327	3373	3205	3327	3136
17 † Reach at Maximum Lift and 45° Discharge	mm	1569	1703	1602	1578	1712	1602	1915
Reach at Level Lift Arm and Bucket Level	mm	3257	3468	3307	3258	3469	3307	3657
A † Digging Depth	mm	116	116	116	104	104	116	107
12 † Shipping Length (with Bucket)	mm	10 168	10 403	10 218	10 162	10 397	10 218	10 586
B † Overall Height with Bucket at Maximum Lift	mm	6592	6592	6642	6592	6592	6642	6540
Loader Clearance Circle with Bucket at Carry Position	mm	15 769	15 986	15 800	15 761	15 978	15 800	16 073
Static Tipping Load, Straight (With Tire Deflection)*	kg	24 791	24 692	24 620	24 130	24 032	24 583	23 809
Static Tipping Load, Straight (No Tire Deflection)*	kg	26 101	26 001	25 938	25 440	25 340	25 901	25 108
Static Tipping Load, Articulated (With Tire Deflection)*	kg	21 080	20 981	20 918	20 414	20 315	20 881	20 062
Static Tipping Load, Articulated (No Tire Deflection)*	kg	22 393	22 293	22 239	21 725	21 626	22 201	21 364
Breakout Force**	kN	260	259	251	257	257	251	232
Operating Weight*	kg	35 564	35 636	35 655	36 227	36 299	35 695	36 694

*Static tipping loads and operating weights shown are based on a machine configuration with Bridgestone 875/65R29 VLTS L4 radial tires, full fluids, operator, standard counterweight, cold start, roading fenders, Product Link, limited slip differentials, power train guard, secondary steering and sound suppression.

**Measured 102 mm behind tip of cutting edge with bucket hinge pin as pivot in accordance with SAE J732C.

Specifications and ratings conform to all applicable standards recommended by the Society of Automotive Engineers, including SAE Standard J732C governing loader ratings.

(With Tire Deflection) Full compliance to ISO 14397-1 (2007) Sections 1 thru 6, which requires 2% verification between calculations and testing.

(No Tire Deflection) Compliance to ISO 14397-1 (2007) Sections 1 thru 5.

†Illustration shown with Dimension charts.

Other buckets are available and offerings vary by region. Consult your local Cat dealer for further details.

980M/982M Wheel Loaders Specifications

982M Operating Specifications with Buckets – Aggregate Handler

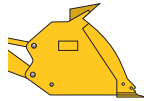
Linkage		Aggregate Handler					
Pin/Quick Coupler							
		Pin On					
Bucket Type		General Purpose	Heavy Duty General Purpose		Material Handling		Heavy Duty Material Handling
		Bolt-On Cutting Edges	Bolt-On Cutting Edges	Bolt-On Cutting Edges	Bolt-On Cutting Edges	Bolt-On Cutting Edges	Bolt-On Cutting Edges
Capacity – Rated	m ³	6.40	6.40	7.00	6.40	7.00	6.40
Capacity – Rated at 110% Fill Factor	m ³	7.04	7.04	7.70	7.04	7.70	7.04
Width	mm	3602	3602	3602	3602	3602	3602
16 † Dump Clearance at Maximum Lift and 45° Discharge	mm	3312	3312	3262	3233	3185	3248
17 † Reach at Maximum Lift and 45° Discharge	mm	1602	1602	1644	1516	1581	1518
Reach at Level Lift Arm and Bucket Level	mm	3307	3307	3374	3321	3401	3311
A † Digging Depth	mm	132	132	132	132	120	120
12 † Shipping Length (with Bucket)	mm	10 335	10 335	10 402	10 349	10 421	10 331
B † Overall Height with Bucket at Maximum Lift	mm	6627	6626	6693	6610	6694	6607
Loader Clearance Circle with Bucket at Carry Position	mm	15 801	15 801	15 842	15 809	15 850	15 794
Static Tipping Load, Straight (With Tire Deflection)*	kg	26 038	26 001	25 761	25 592	24 471	24 813
Static Tipping Load, Straight (No Tire Deflection)*	kg	27 454	27 416	27 186	26 964	25 850	26 181
Static Tipping Load, Articulated (With Tire Deflection)*	kg	22 083	22 045	21 816	21 694	20 578	20 907
Static Tipping Load, Articulated (No Tire Deflection)*	kg	23 507	23 469	23 249	23 076	21 966	22 285
Breakout Force**	kN	251	251	240	249	232	247
Operating Weight*	kg	36 302	36 342	36 483	36 370	37 355	37 148

*Static tipping loads and operating weights shown are based on a machine configuration with Bridgestone 875/65R29 VLTS L4 radial tires, full fluids, operator, aggregate counterweight, cold start, roading fenders, Product Link, limited slip differentials, power train guard, secondary steering and sound suppression.

**Measured 102 mm behind tip of cutting edge with bucket hinge pin as pivot in accordance with SAE J732C.

Specifications and ratings conform to all applicable standards recommended by the Society of Automotive Engineers, including SAE Standard J732C governing loader ratings.

(With Tire Deflection) Full compliance to ISO 14397-1 (2007) Sections 1 thru 6, which requires 2% verification between calculations and testing.

(No Tire Deflection) Compliance to ISO 14397-1 (2007) Sections 1 thru 5.

†Illustration shown with Dimension charts.

Aggregate Handler configuration is not compatible with teeth and segments, tips, rock buckets, high lift, and L5 tires.

Other buckets are available and offerings vary by region. Consult your local Cat dealer for further details.

980M/982M Standard Equipment

Standard Equipment

Standard equipment may vary. Consult your Cat dealer for details.

OPERATOR ENVIRONMENT

- Cab, pressurized and sound suppressed (ROPS/FOPS)
- Viscous mounts
- Multi-function 18 cm color LCD touch-screen display for rear vision camera image display (reverse travel activated) and machine status, setting and health parameters
- EH controls, SAL (single axis levers) lift and tilt function
- Steering, EH joystick, speed sensing with force feedback
- Radio ready (entertainment) includes antenna, speakers and converter (12V, 10-amp)
- Air conditioner, heater, and defroster (auto temp and fan)
- EH parking brake
- Beverage holders (2) with storage compartment for cell phone/MP3 player
- Bucket/work tool function lockout
- Coat hook (2)
- Cab air filter
- Ergonomic cab access ladders and handrails
- Horn, electric
- Light, two dome (cab)
- Mirrors, rearview external with integrated spot mirrors
- Post mounted membrane 16 switch keypad
- 3 receptacles, 12V
- Seat, Cat Comfort (cloth) air suspension
- Seat belt, 51 mm retractable, with indicator
- Steering, secondary
- Sun visor, front
- Wet-arm wipers/washers front and rear, intermittent front wiper
- Window, sliding (left and right sides)
- Cab tie-off

COMPUTERIZED MONITORING SYSTEM

- With following gauges:
 - Speedometer/tachometer
 - Digital gear range indicator
 - Diesel Exhaust Fluid (DEF) level
 - Temperature: engine coolant, hydraulic oil, transmission oil
 - Fuel level

- With following warning indicators:
 - Regeneration
 - Temperature: axle oil, engine intake manifold
 - Pressure: engine oil, fuel pressure hi/low, primary steering oil, service brake oil
 - Battery voltage hi/low
 - Engine air filter restriction
 - Hydraulic oil filter restriction
 - Hydraulic oil low
 - Parking brake
 - DEF low level
 - Transmission filter bypass

ELECTRICAL AND LIGHTING

- Batteries (2), maintenance free 1,400 CCA
- Ignition key; start/stop switch
- Starter, electric, heavy duty
- Starting and charging system (24V)
- Lighting system:
 - Four halogen work lights (cab mounted)
 - Two halogen roading lights (with signals)
 - Two halogen rear vision lights (hood mounted)
- Alarm, back-up
- Alternator, 145-amp brushed
- Main disconnect switch
- Receptacle start (cables not included)

CAT CONNECT TECHNOLOGIES

- Link technologies: Product Link
- Detect technologies: rear vision camera

POWER TRAIN

- Engine, Cat C13 ACERT meets Stage IV emission standards
- Cat Clean Emissions Module (CEM) with Diesel Exhaust Fluid (DEF) tank and pump
- Fuel priming pump (electric)
- Fuel/water separator
- Precleaner, engine air intake
- Economy Mode (selectable)
- Transmission, automatic planetary power shift (4F/4R)
- Torque converter, locking clutch with free wheel stator
- Switch, transmission neutralizer lockout
- Axles, open differential, front and rear
- Heavy duty transmission (982M)
- Axles, ecology drains
- Brakes, full hydraulic enclosed wet-disc with Integrated Braking System (IBS)

- Brake wear indicators
- Parking brake, disc and caliper
- Fan, radiator, electronically controlled, hydraulically driven, temperature sensing, on demand
- Radiator, high debris, 6 fins per inch, 43° cooling capacity

LINKAGE

- Linkage, Z-bar, cast crosstube/tilt levers
- Kickout, lift and tilt, automatic (adjustable in cab)

HYDRAULICS

- Hydraulic system, load sensing
- Steering, load sensing
- Ride control, 2V
- Remote diagnostic pressure taps
- Hoses, Cat XT™
- Couplings, Cat O-ring face seal
- Hydraulic oil cooler (swing out)
- Oil sampling valves

FLUIDS

- Premixed extended life coolant with freeze protection to –34° C

OTHER STANDARD EQUIPMENT

- One-piece tilting hood with side and rear doors
- Service centers (electrical and hydraulic)
- Platform, window washing
- Auto idle shutdown
- Fenders, steel front with mud-flap/rear with extension
- Guard, power train
- Ecology drains for engine, transmission, and hydraulics
- Ether aid ready
- Grill, airborne debris
- Filters: fuel, engine air, engine oil, hydraulic oil, transmission
- Fuel cooler
- Grease zerks
- Hitch, drawbar with pin
- Precleaner rain cap
- Sight gauges: engine coolant, hydraulic oil, and transmission oil level
- Toolbox
- Vandalism protection caplocks

Optional Equipment

Optional equipment may vary. Consult your Cat dealer for details.

OPERATOR ENVIRONMENT

- Door, remote opening system
- Cover, HVAC metallic
- EH controls, SAL 3rd function
- EH controls, joystick lift and tilt
 - Additional integrated roller switches for 3rd function
- Filter, carbon fresh air
- Mirrors, heated rearview external with integrated spot mirrors
- Precleaner, HVAC
- Precleaner, HVAC (RESPA)
- Radio, AM/FM/CD/USB/MP3 Bluetooth
- Radio, CB ready
- Seat, heated air suspension
- Steering, EH wheel with directional FNR shifter and gear selector
 - Additional FNR with implement controls
- Roof, metallic
- Sun visor, rear
- Windows, rubber mounted
- Windows, with front guard
- Windows, with heavy duty front guard
- Windows, with full guards front, rear and sides

ELECTRICAL AND LIGHTING

- Four additional auxiliary halogen cab mounted work lights or
- Two additional auxiliary front HI LED and two additional auxiliary rear LED cab mounted work lights with two LED work lights in the radiator grill and LED front turn signals also includes replacement of the standard four halogen cab mounted work lights with four LED work lights (the standard offering and only roading light available is the halogen roading light)
- Warning amber strobe beacon
- Reversing strobes
- External seat belt indicator light
- Speed limiter – 20 km/h (Europe only)

STARTERS, BATTERIES, AND ALTERNATORS

- Batteries (4), maintenance free 1,400 CCA With 240V Engine Coolant Heater

CAT CONNECT TECHNOLOGIES

- Link technologies: VIMS™
- Payload technologies:
 - Aggregate Autodig
 - Cat Production Measurement 2.0
 - Printer
- Detect technologies:
 - Cat Rear Object Detection
- Machine Security System

POWER TRAIN

- Axles
 - Differentials: limited slip, front or rear
 - Axle oil cooler
- Heavy duty transmission (980M)
- Fan, VPF (variable pitch fan), automatic and manual control
- Radiator, low debris, 9 fins per inch, high ambient 47° cooling capacity

LINKAGE

- High lift (980M)
- Logger (980M)
- Quick coupler ready

WORK TOOLS

- Performance Series buckets
- Forks, pallet
- Forks, logging

HYDRAULICS

- 3rd function with Ride Control
 - Standard linkage
 - High lift linkage (980M)
 - Logger linkage

FLUIDS

- Premixed extended life coolant with freeze protection to –50° C

OTHER OPTIONAL EQUIPMENT

- Cat Autolube System
- Wheel chocks
- Fenders, roading
- Oil change, high speed engine
- Fuel tank, fast fill
- Precleaner, turbine
- Precleaner, trash

OTHER OPTIONAL CONFIGURATIONS

- High Lift (980M)
- Steel Mill (980M)
- Logger (980M)
- Block Handler (980M)
- Aggregate Handler (980M, 982M)

For more complete information on Cat products, dealer services, and industry solutions, visit us on the web at www.cat.com

AEHQ7963
(Europe)

© 2016 Caterpillar
All rights reserved

Materials and specifications are subject to change without notice. Featured machines in photos may include additional equipment. See your Cat dealer for available options.

CAT, CATERPILLAR, SAFETY.CAT.COM, their respective logos, "Caterpillar Yellow" and the "Power Edge" trade dress, as well as corporate and product identity used herein, are trademarks of Caterpillar and may not be used without permission.

VisionLink is a trademark of Trimble Navigation Limited, registered in the United States and in other countries.

